





#1 Hollister-Whitney Parkway  
 Quincy, IL 62305  
 Phone: 217-222-0466  
 Fax: 217-222-0493

*Hollister-Whitney*  
 ELEVATOR CO. LLC

www.hollisterwhitney.com  
 sales@hwec.com  
 layouts@hwec.com  
 engineering@hwec.com

ENGINEERING CONTACT: \_\_\_\_\_ JOB NAME: \_\_\_\_\_  
 COMPANY: \_\_\_\_\_ ELEV. #: \_\_\_\_\_ H-W #: \_\_\_\_\_ DATE: \_\_\_\_\_  
 EMAIL: \_\_\_\_\_ FROM (H-W): \_\_\_\_\_  
 FAX NO: \_\_\_\_\_ FILL OUT SURVEY FORM AS COMPLETE AS POSSIBLE.

**SINGLE OPENING - CWT. AT REAR**

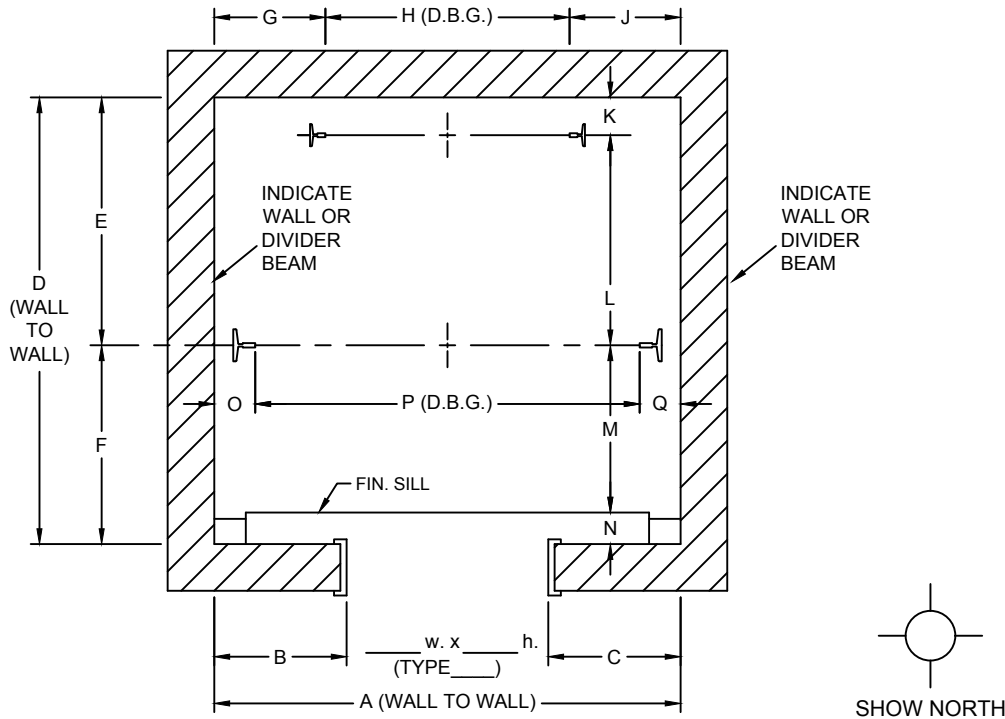

DIMENSIONS AT TIGHTEST POINT	
A	
B	
C	
D	
E	
F	
G	
H	
J	
K	
L	
M	
N	
O	
P	
Q	
R	
S	
T	
U	
V	
W	
X	
Y	

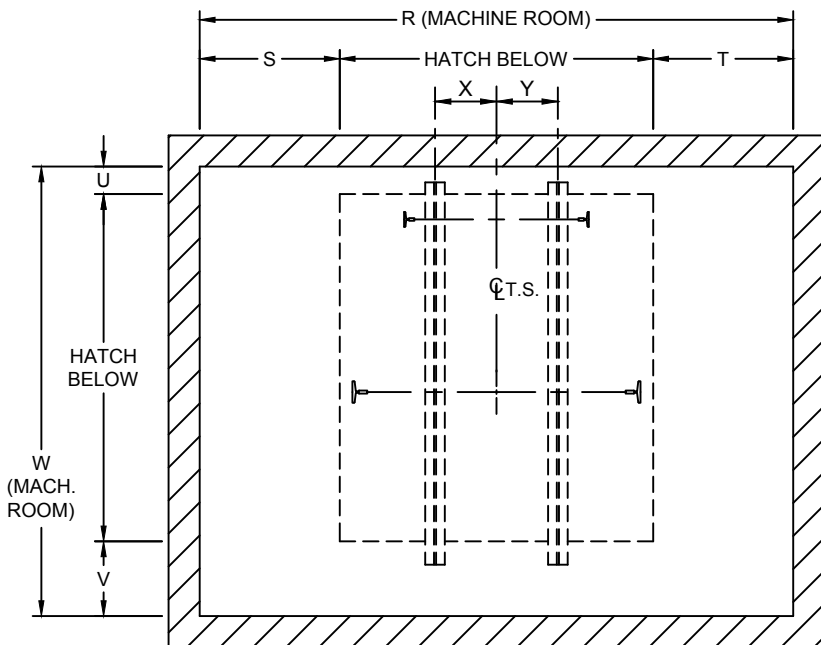

MACHINE BEAM SIZE: \_\_\_\_\_ H. x \_\_\_\_\_ W.  
 INDICATE MACHINE ROOM DOOR LOCATION & HAND

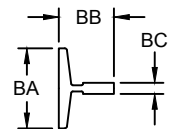

RAIL DIMENSIONS		
	CAR	CWT.
BA		
BB		
BC		
LB./FT.		



#1 Hollister-Whitney Parkway  
 Quincy, IL 62305  
 Phone: 217-222-0466  
 Fax: 217-222-0493

*Hollister-Whitney*  
 ELEVATOR CO. LLC

www.hollisterwhitney.com  
 sales@hwec.com  
 layouts@hwec.com  
 engineering@hwec.com

ENGINEERING CONTACT: \_\_\_\_\_ JOB NAME: \_\_\_\_\_  
 COMPANY: \_\_\_\_\_ ELEV. #: \_\_\_\_\_ H-W #: \_\_\_\_\_ DATE: \_\_\_\_\_  
 EMAIL: \_\_\_\_\_ FROM (H-W): \_\_\_\_\_  
 FAX NO: \_\_\_\_\_ FILL OUT SURVEY FORM AS COMPLETE AS POSSIBLE.

**SINGLE OPENING - LEFT HAND DOOR - CWT. ON RIGHT**

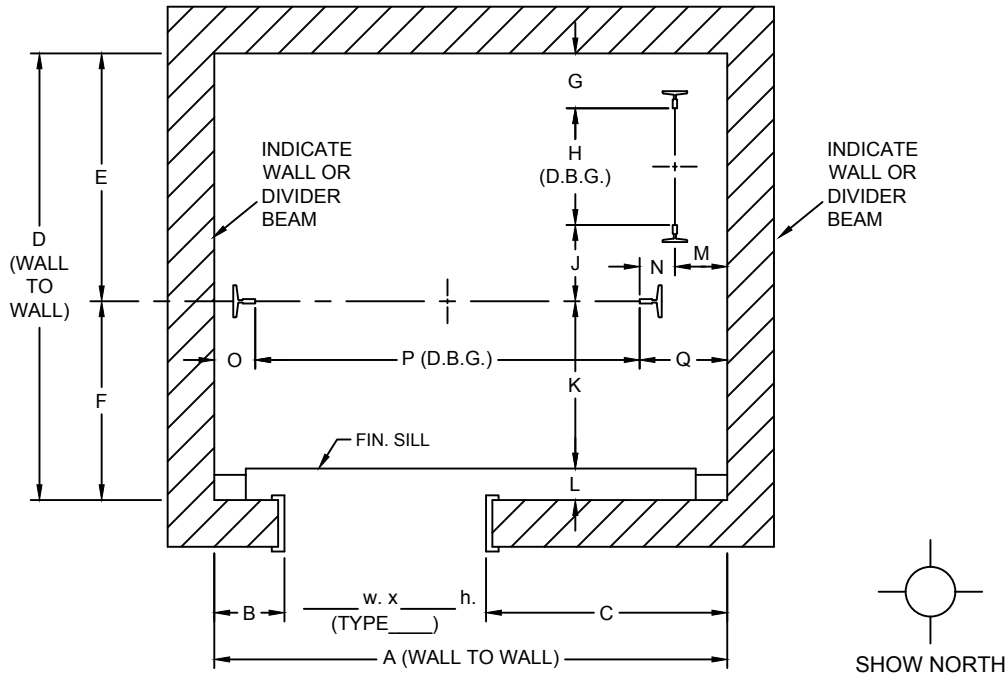

DIMENSIONS AT TIGHTEST POINT	
A	
B	
C	
D	
E	
F	
G	
H	
J	
K	
L	
M	
N	
O	
P	
Q	
R	
S	
T	
U	
V	
W	
X	
Y	
Z	
AA	

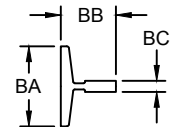
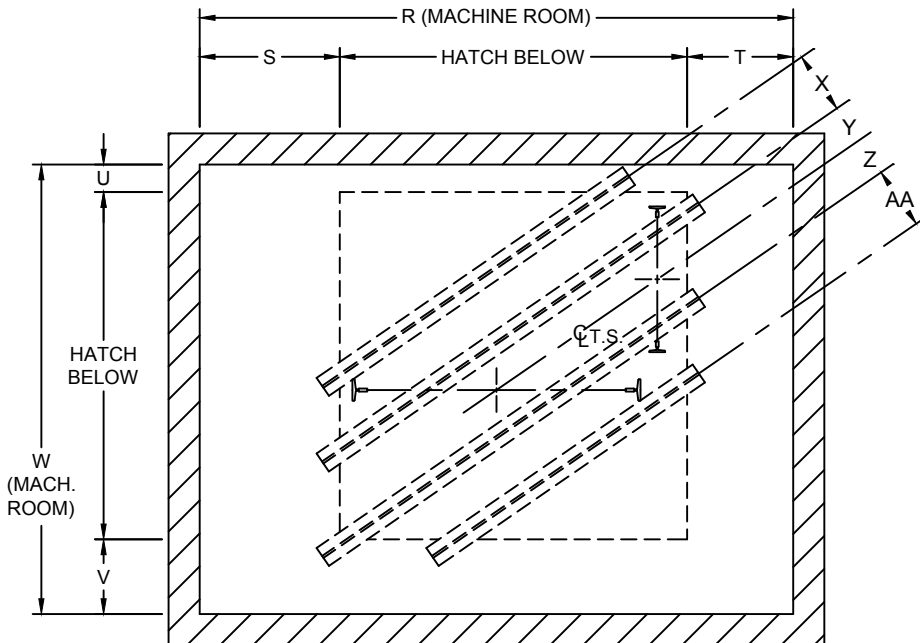

MACHINE BEAM SIZE: \_\_\_\_\_ H. x \_\_\_\_\_ W.  
 INDICATE MACHINE ROOM DOOR LOCATION & HAND

RAIL DIMENSIONS		
	CAR	CWT.
BA		
BB		
BC		
LB./FT.		



#1 Hollister-Whitney Parkway  
 Quincy, IL 62305  
 Phone: 217-222-0466  
 Fax: 217-222-0493

*Hollister-Whitney*  
 ELEVATOR CO. LLC

www.hollisterwhitney.com  
 sales@hwec.com  
 layouts@hwec.com  
 engineering@hwec.com

ENGINEERING CONTACT: \_\_\_\_\_ JOB NAME: \_\_\_\_\_  
 COMPANY: \_\_\_\_\_ ELEV. #: \_\_\_\_\_ H-W #: \_\_\_\_\_ DATE: \_\_\_\_\_  
 EMAIL: \_\_\_\_\_ FROM (H-W): \_\_\_\_\_  
 FAX NO: \_\_\_\_\_ FILL OUT SURVEY FORM AS COMPLETE AS POSSIBLE.

**SINGLE OPENING - RIGHT HAND DOOR - CWT. ON LEFT**

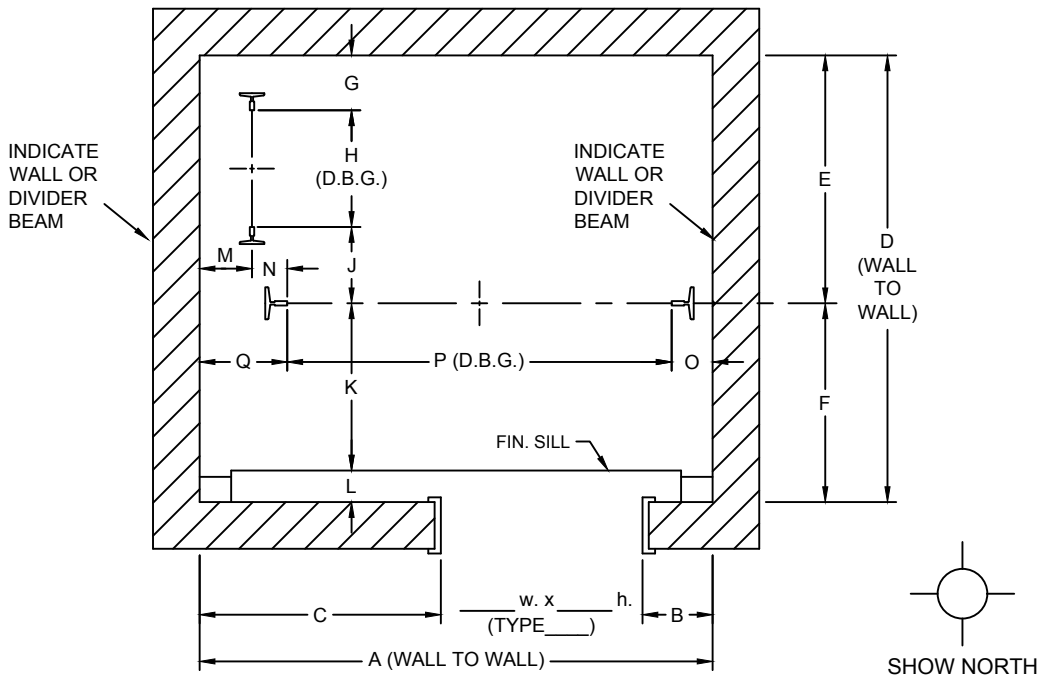

DIMENSIONS AT TIGHTEST POINT	
A	
B	
C	
D	
E	
F	
G	
H	
J	
K	
L	
M	
N	
O	
P	
Q	
R	
S	
T	
U	
V	
W	
X	
Y	
Z	
AA	

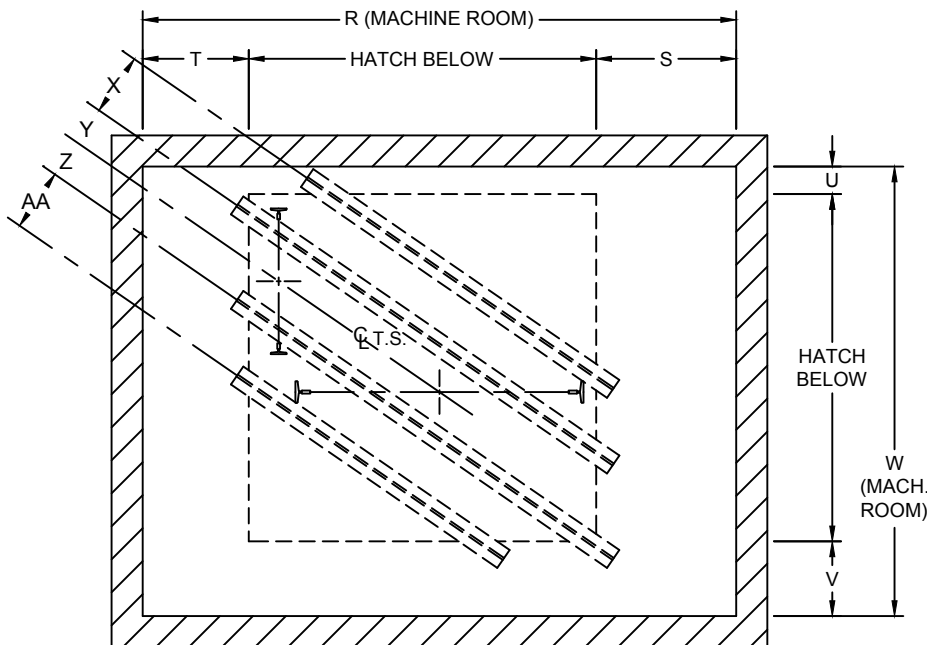

MACHINE BEAM SIZE: \_\_\_\_\_ H. x \_\_\_\_\_ W.  
 INDICATE MACHINE ROOM DOOR LOCATION & HAND

RAIL DIMENSIONS		
	CAR	CWT.
BA		
BB		
BC		
LB./FT.		



#1 Hollister-Whitney Parkway  
 Quincy, IL 62305  
 Phone: 217-222-0466  
 Fax: 217-222-0493

*Hollister-Whitney*  
 ELEVATOR CO. LLC

www.hollisterwhitney.com  
 sales@hwec.com  
 layouts@hwec.com  
 engineering@hwec.com

ENGINEERING CONTACT: \_\_\_\_\_ JOB NAME: \_\_\_\_\_  
 COMPANY: \_\_\_\_\_ ELEV. #: \_\_\_\_\_ H-W #: \_\_\_\_\_ DATE: \_\_\_\_\_  
 EMAIL: \_\_\_\_\_ FROM (H-W): \_\_\_\_\_  
 FAX NO: \_\_\_\_\_ FILL OUT SURVEY FORM AS COMPLETE AS POSSIBLE.

**SINGLE OPENING - LEFT HAND DOOR - CWT. ON LEFT**

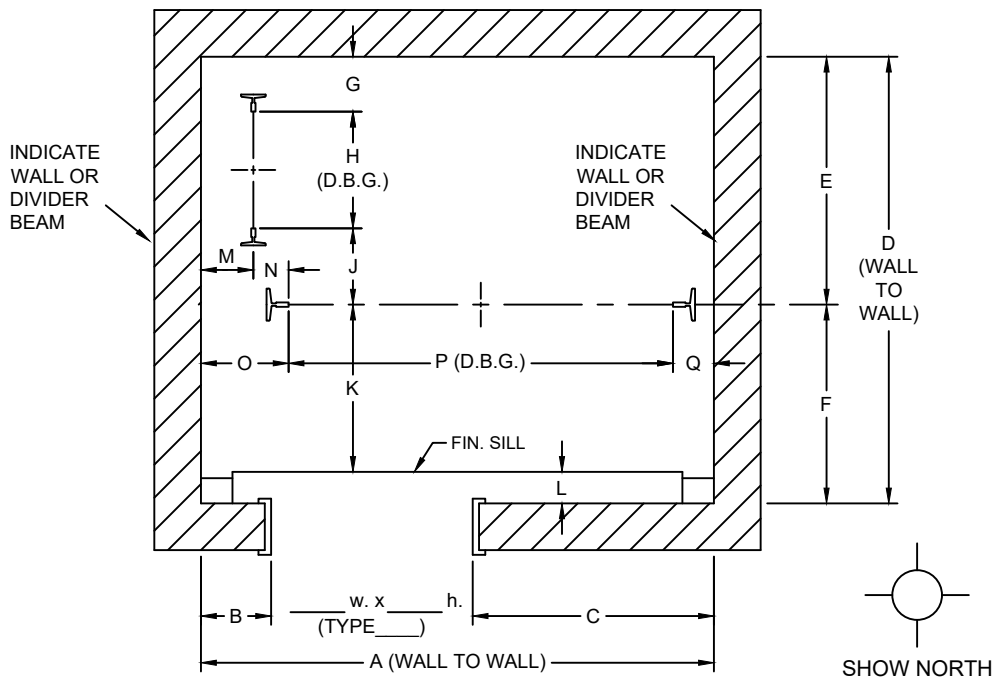

DIMENSIONS AT TIGHTEST POINT	
A	
B	
C	
D	
E	
F	
G	
H	
J	
K	
L	
M	
N	
O	
P	
Q	
R	
S	
T	
U	
V	
W	
X	
Y	
Z	
AA	

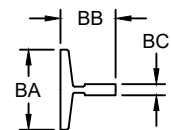
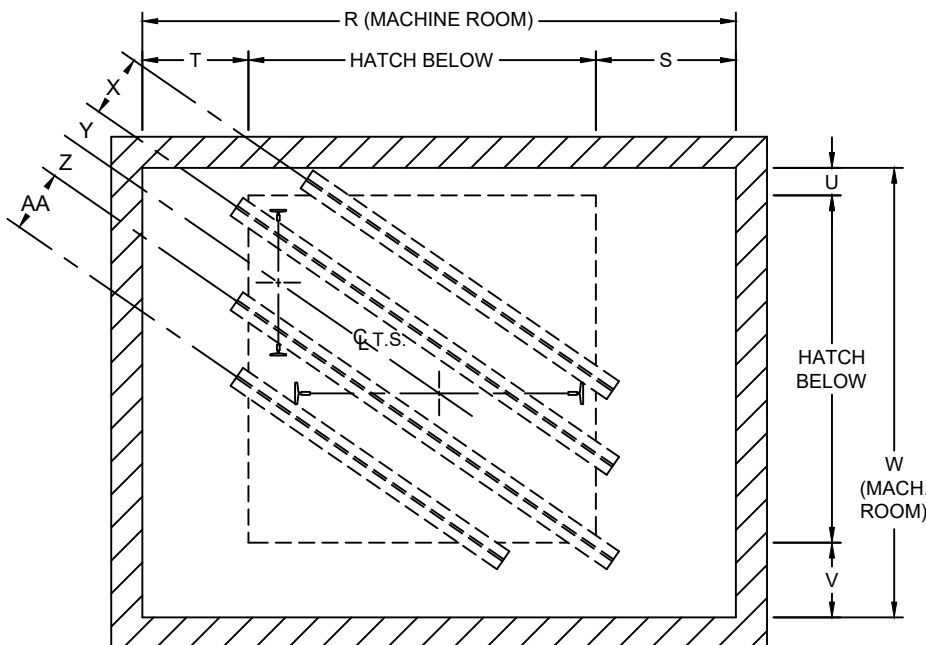

RAIL DIMENSIONS		
	CAR	CWT.
BA		
BB		
BC		
LB./FT.		

MACHINE BEAM SIZE: \_\_\_\_\_ H. x \_\_\_\_\_ W.  
 INDICATE MACHINE ROOM DOOR LOCATION & HAND



#1 Hollister-Whitney Parkway  
 Quincy, IL 62305  
 Phone: 217-222-0466  
 Fax: 217-222-0493

*Hollister-Whitney*  
 ELEVATOR CO. LLC

www.hollisterwhitney.com  
 sales@hwec.com  
 layouts@hwec.com  
 engineering@hwec.com

ENGINEERING CONTACT: \_\_\_\_\_ JOB NAME: \_\_\_\_\_  
 COMPANY: \_\_\_\_\_ ELEV. #: \_\_\_\_\_ H-W #: \_\_\_\_\_ DATE: \_\_\_\_\_  
 EMAIL: \_\_\_\_\_ FROM (H-W): \_\_\_\_\_  
 FAX NO: \_\_\_\_\_ FILL OUT SURVEY FORM AS COMPLETE AS POSSIBLE.

**SINGLE OPENING - RIGHT HAND DOOR - CWT. ON RIGHT**

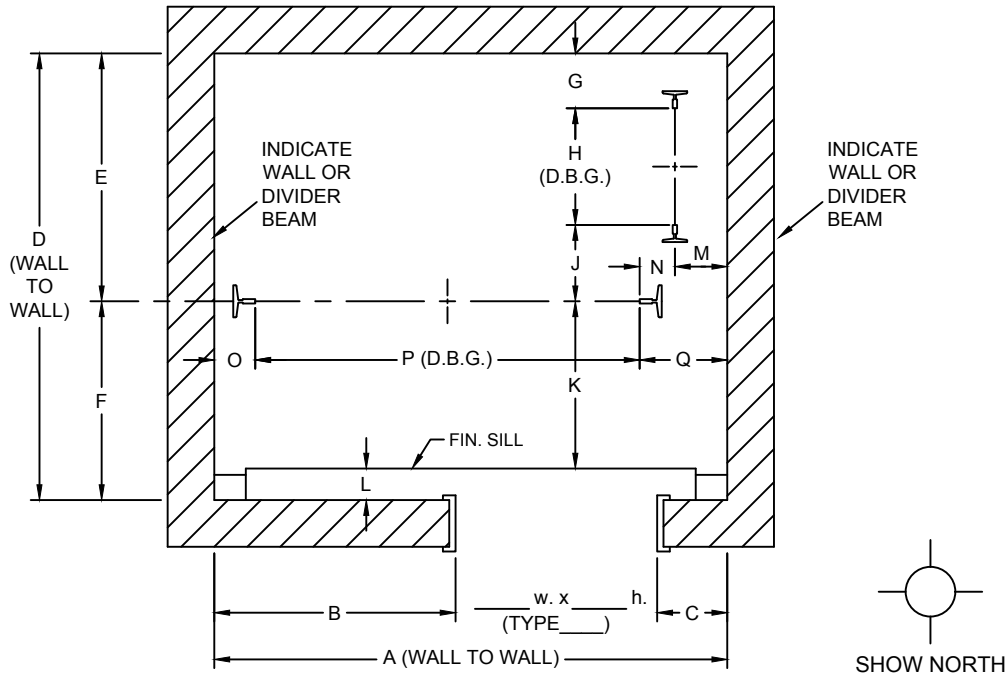

DIMENSIONS AT TIGHTEST POINT	
A	
B	
C	
D	
E	
F	
G	
H	
J	
K	
L	
M	
N	
O	
P	
Q	
R	
S	
T	
U	
V	
W	
X	
Y	
Z	
AA	

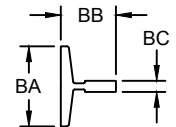
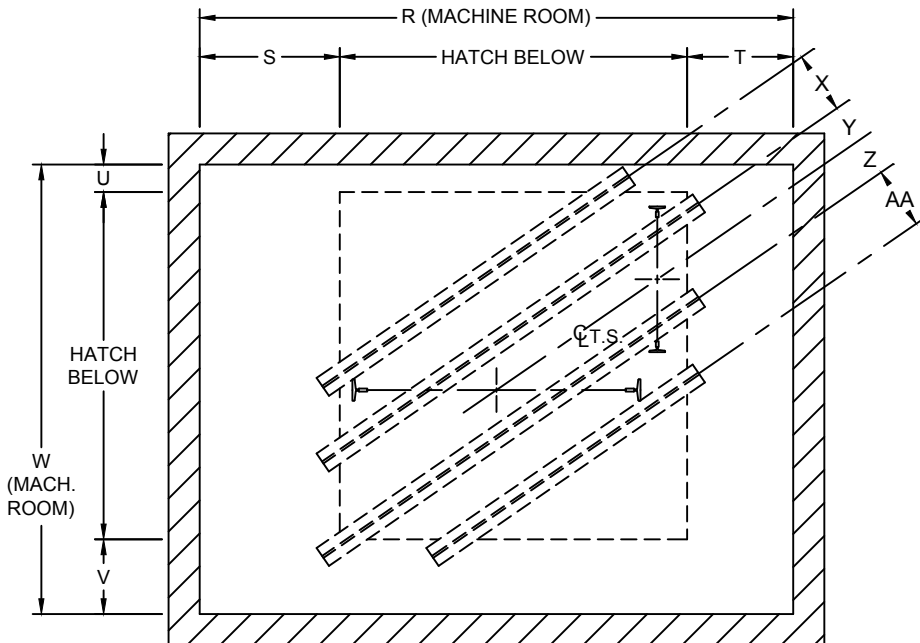

MACHINE BEAM SIZE: \_\_\_\_\_ H. x \_\_\_\_\_ W.  
 INDICATE MACHINE ROOM DOOR LOCATION & HAND

RAIL DIMENSIONS		
	CAR	CWT.
BA		
BB		
BC		
LB./FT.		



#1 Hollister-Whitney Parkway  
 Quincy, IL 62305  
 Phone: 217-222-0466  
 Fax: 217-222-0493

*Hollister-Whitney*  
 ELEVATOR CO. LLC

www.hollisterwhitney.com  
 sales@hwec.com  
 layouts@hwec.com  
 engineering@hwec.com

ENGINEERING CONTACT: \_\_\_\_\_ JOB NAME: \_\_\_\_\_  
 COMPANY: \_\_\_\_\_ ELEV. #: \_\_\_\_\_ H-W #: \_\_\_\_\_ DATE: \_\_\_\_\_  
 EMAIL: \_\_\_\_\_ FROM (H-W): \_\_\_\_\_  
 FAX NO: \_\_\_\_\_ FILL OUT SURVEY FORM AS COMPLETE AS POSSIBLE.

**DOUBLE OPENING - LEFT HAND DOOR - CWT. ON RIGHT**

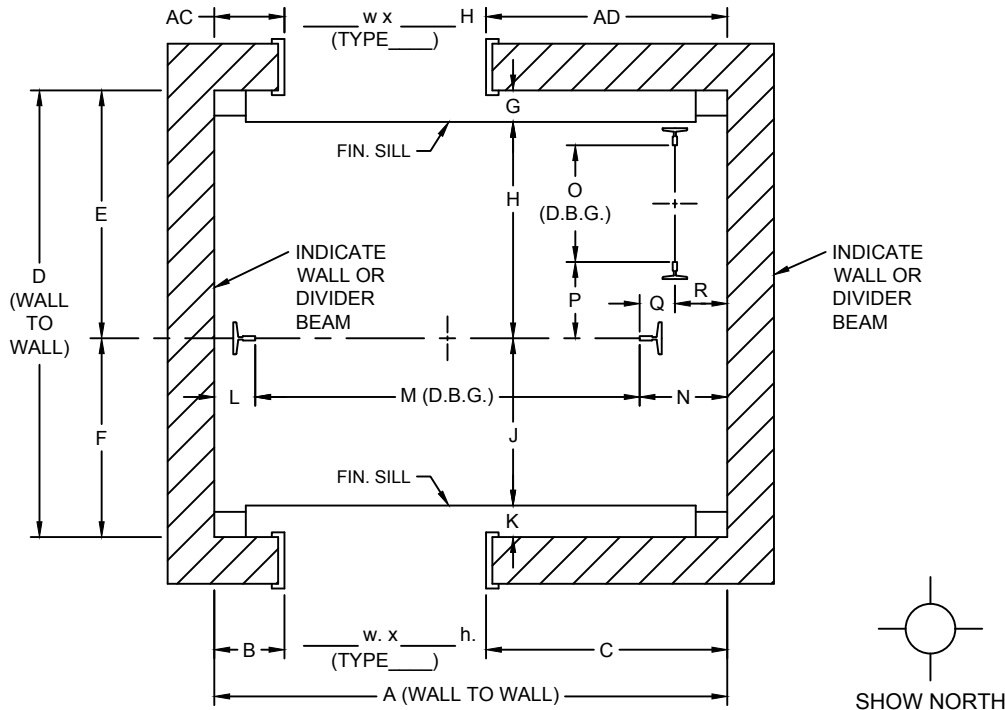

DIMENSIONS AT TIGHTEST POINT	
A	
B	
C	
D	
E	
F	
G	
H	
J	
K	
L	
M	
N	
O	
P	
Q	
R	
S	
T	
U	
V	
W	
X	
Y	
Z	
AA	
AB	
AC	
AD	

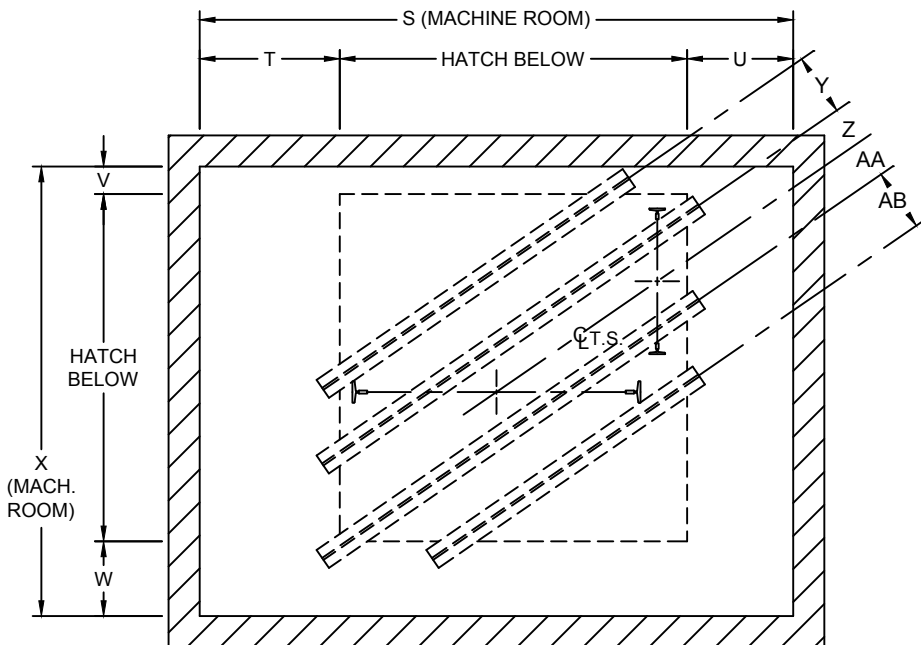

MACHINE BEAM SIZE: \_\_\_\_\_ H. x \_\_\_\_\_ W.  
 INDICATE MACHINE ROOM DOOR LOCATION & HAND

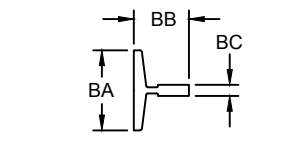

RAIL DIMENSIONS		
	CAR	CWT.
BA		
BB		
BC		
LB./FT.		



#1 Hollister-Whitney Parkway  
 Quincy, IL 62305  
 Phone: 217-222-0466  
 Fax: 217-222-0493

*Hollister-Whitney*  
 ELEVATOR CO. LLC

www.hollisterwhitney.com  
 sales@hwec.com  
 layouts@hwec.com  
 engineering@hwec.com

ENGINEERING CONTACT: \_\_\_\_\_ JOB NAME: \_\_\_\_\_  
 COMPANY: \_\_\_\_\_ ELEV. #: \_\_\_\_\_ H-W #: \_\_\_\_\_ DATE: \_\_\_\_\_  
 EMAIL: \_\_\_\_\_ FROM (H-W): \_\_\_\_\_  
 FAX NO: \_\_\_\_\_ FILL OUT SURVEY FORM AS COMPLETE AS POSSIBLE.

**DOUBLE OPENING - RIGHT HAND DOOR - CWT. ON LEFT**

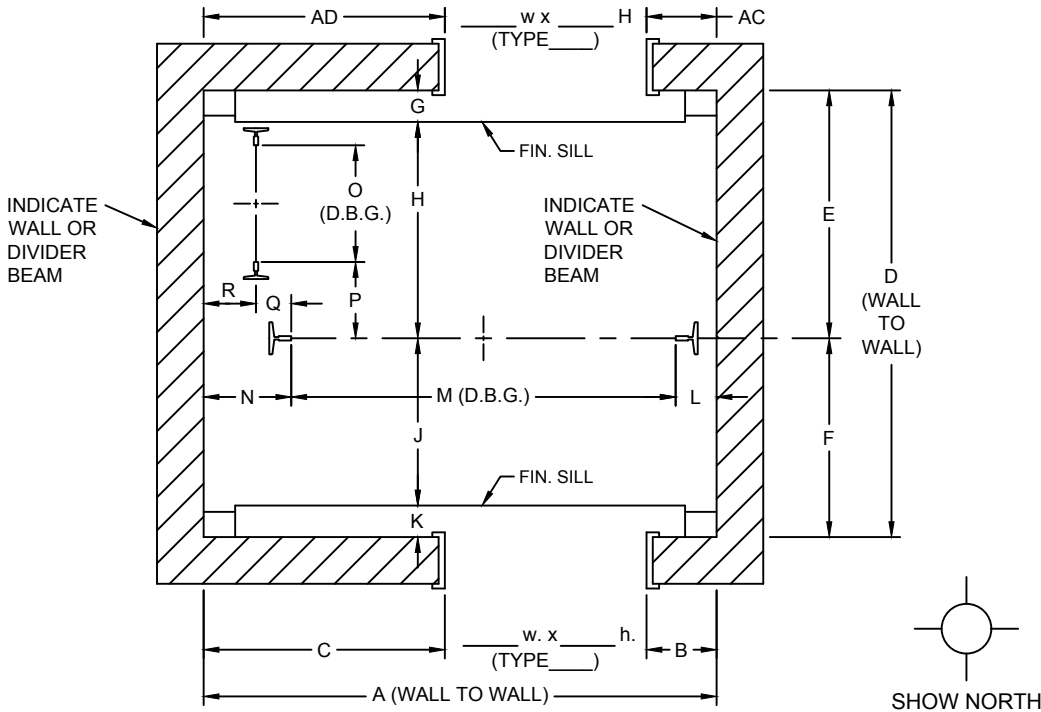

DIMENSIONS AT TIGHTEST POINT	
A	
B	
C	
D	
E	
F	
G	
H	
J	
K	
L	
M	
N	
O	
P	
Q	
R	
S	
T	
U	
V	
W	
X	
Y	
Z	
AA	
AB	
AC	
AD	

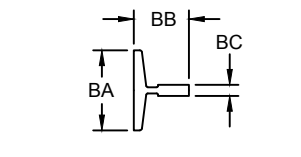
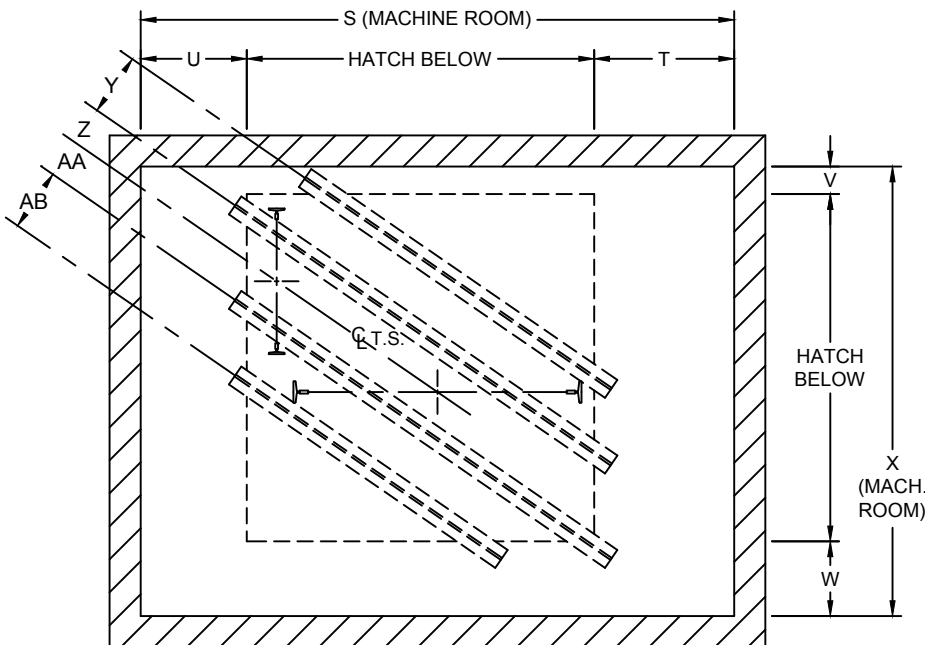

RAIL DIMENSIONS		
	CAR	CWT.
BA		
BB		
BC		
LB./FT.		

MACHINE BEAM SIZE: \_\_\_\_\_ H. x \_\_\_\_\_ W.  
 INDICATE MACHINE ROOM DOOR LOCATION & HAND





#1 Hollister-Whitney Parkway  
 Quincy, IL 62305  
 Phone: 217-222-0466  
 Fax: 217-222-0493

*Hollister-Whitney*  
 ELEVATOR CO. LLC

www.hollisterwhitney.com  
 sales@hwec.com  
 layouts@hwec.com  
 engineering@hwec.com

ENGINEERING CONTACT: \_\_\_\_\_ JOB NAME: \_\_\_\_\_  
 COMPANY: \_\_\_\_\_ ELEV. #: \_\_\_\_\_ H-W #: \_\_\_\_\_ DATE: \_\_\_\_\_  
 EMAIL: \_\_\_\_\_ FROM (H-W): \_\_\_\_\_  
 FAX NO: \_\_\_\_\_ FILL OUT SURVEY FORM AS COMPLETE AS POSSIBLE.

**DOUBLE OPENING - LEFT HAND DOOR - CWT. ON LEFT**

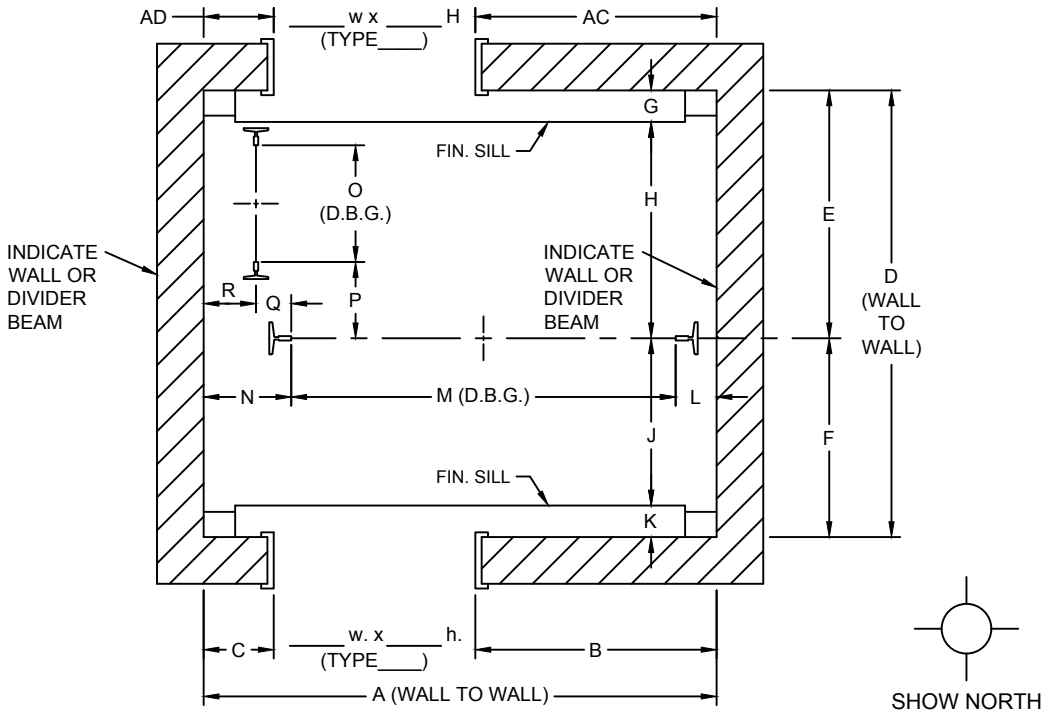

DIMENSIONS AT TIGHTEST POINT	
A	
B	
C	
D	
E	
F	
G	
H	
J	
K	
L	
M	
N	
O	
P	
Q	
R	
S	
T	
U	
V	
W	
X	
Y	
Z	
AA	
AB	
AC	
AD	

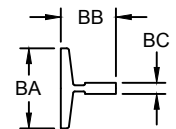
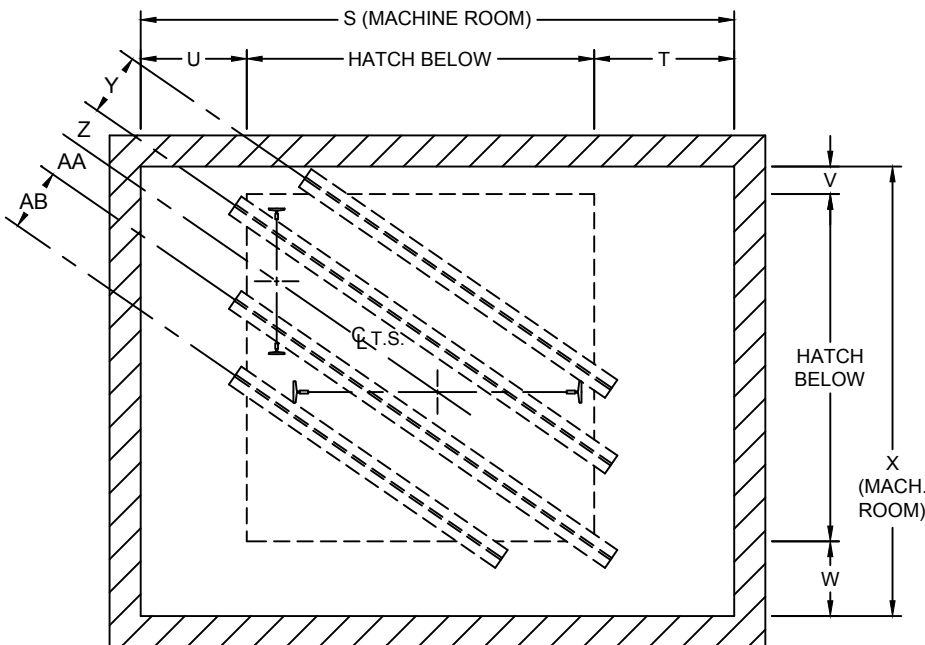

MACHINE BEAM SIZE: \_\_\_\_\_ H. x \_\_\_\_\_ W.  
 INDICATE MACHINE ROOM DOOR LOCATION & HAND

RAIL DIMENSIONS		
	CAR	CWT.
BA		
BB		
BC		
LB./FT.		



#1 Hollister-Whitney Parkway  
 Quincy, IL 62305  
 Phone: 217-222-0466  
 Fax: 217-222-0493

*Hollister-Whitney*  
 ELEVATOR CO. LLC

www.hollisterwhitney.com  
 sales@hwec.com  
 layouts@hwec.com  
 engineering@hwec.com

ENGINEERING CONTACT: \_\_\_\_\_ JOB NAME: \_\_\_\_\_  
 COMPANY: \_\_\_\_\_ ELEV. #: \_\_\_\_\_ H-W #: \_\_\_\_\_ DATE: \_\_\_\_\_  
 EMAIL: \_\_\_\_\_ FROM (H-W): \_\_\_\_\_  
 FAX NO: \_\_\_\_\_ FILL OUT SURVEY FORM AS COMPLETE AS POSSIBLE.

**DOUBLE OPENING - RIGHT HAND DOOR - CWT. ON RIGHT**

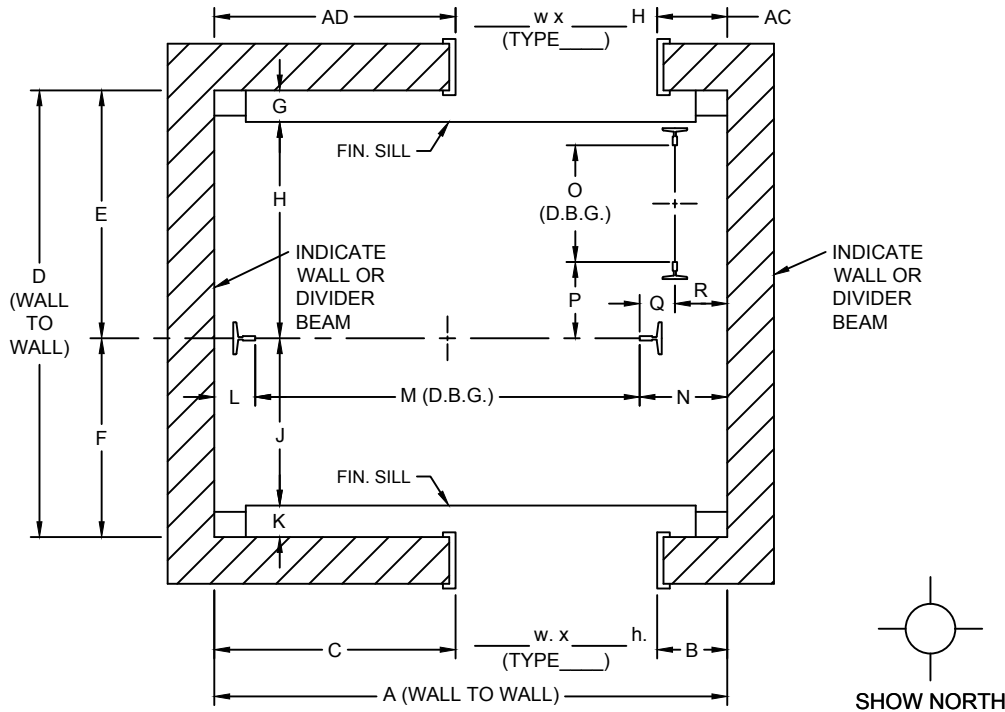

DIMENSIONS AT TIGHTEST POINT	
A	
B	
C	
D	
E	
F	
G	
H	
J	
K	
L	
M	
N	
O	
P	
Q	
R	
S	
T	
U	
V	
W	
X	
Y	
Z	
AA	
AB	
AC	
AD	

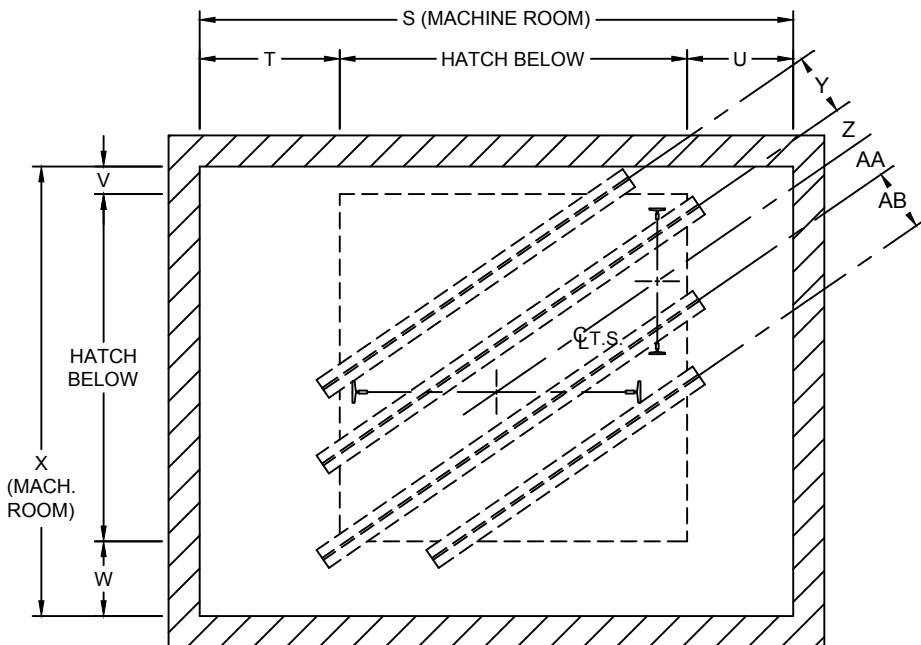

MACHINE BEAM SIZE: \_\_\_\_\_ H. x \_\_\_\_\_ W.  
 INDICATE MACHINE ROOM DOOR LOCATION & HAND

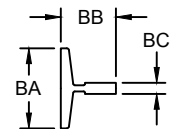

RAIL DIMENSIONS		
	CAR	CWT.
BA		
BB		
BC		
LB./FT.		



#1 Hollister-Whitney Parkway  
 Quincy, IL 62305  
 Phone: 217-222-0466  
 Fax: 217-222-0493

*Hollister-Whitney*  
 ELEVATOR CO. LLC

www.hollisterwhitney.com  
 sales@hwec.com  
 layouts@hwec.com  
 engineering@hwec.com

ENGINEERING CONTACT: \_\_\_\_\_ JOB NAME: \_\_\_\_\_  
 COMPANY: \_\_\_\_\_ ELEV. #: \_\_\_\_\_ H-W #: \_\_\_\_\_ DATE: \_\_\_\_\_  
 EMAIL: \_\_\_\_\_ FROM (H-W): \_\_\_\_\_  
 FAX NO: \_\_\_\_\_ FILL OUT SURVEY FORM AS COMPLETE AS POSSIBLE.

**DOUBLE OPENING - LEFT HAND DOOR - CWT. ON RIGHT**

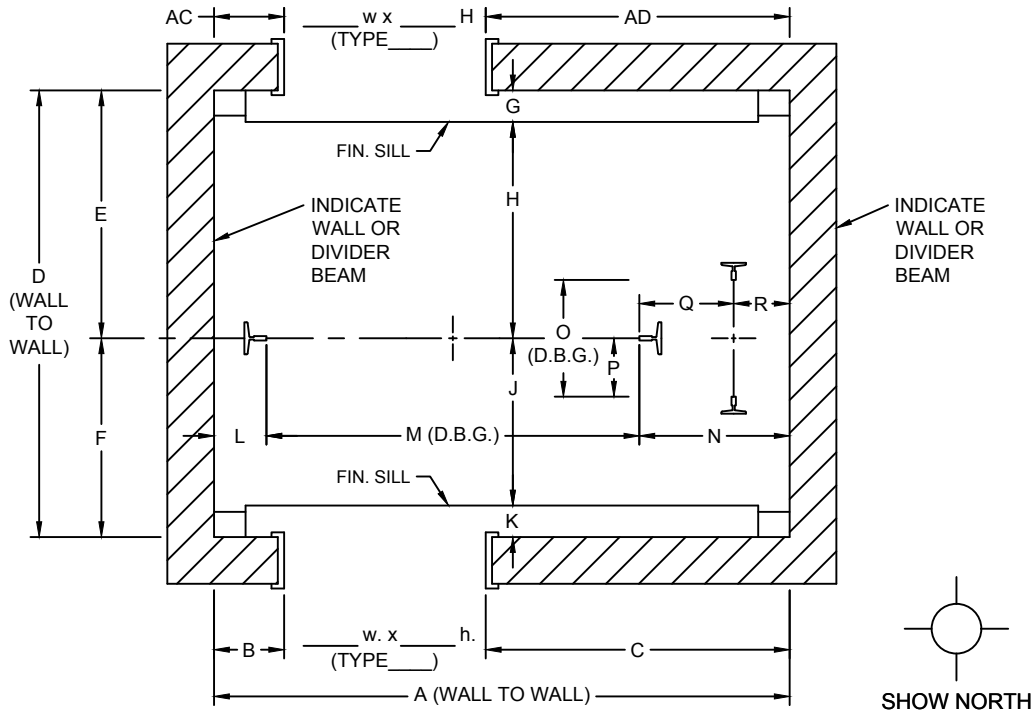

DIMENSIONS AT TIGHTEST POINT	
A	
B	
C	
D	
E	
F	
G	
H	
J	
K	
L	
M	
N	
O	
P	
Q	
R	
S	
T	
U	
V	
W	
X	
Y	
Z	
AA	
AB	
AC	
AD	

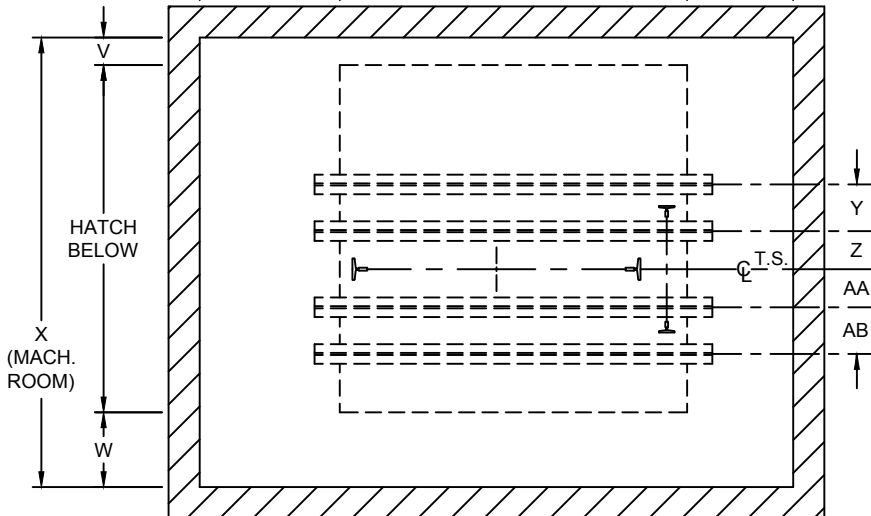
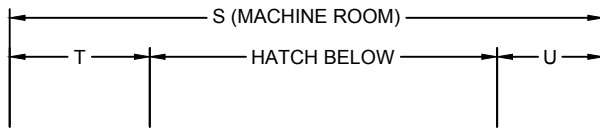

MACHINE BEAM SIZE: \_\_\_\_\_ H. x \_\_\_\_\_ W.  
 INDICATE MACHINE ROOM DOOR LOCATION & HAND

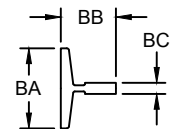

RAIL DIMENSIONS		
	CAR	CWT.
BA		
BB		
BC		
LB./FT.		



#1 Hollister-Whitney Parkway  
 Quincy, IL 62305  
 Phone: 217-222-0466  
 Fax: 217-222-0493

*Hollister-Whitney*  
 ELEVATOR CO. LLC

www.hollisterwhitney.com  
 sales@hwec.com  
 layouts@hwec.com  
 engineering@hwec.com

ENGINEERING CONTACT: \_\_\_\_\_ JOB NAME: \_\_\_\_\_  
 COMPANY: \_\_\_\_\_ ELEV. #: \_\_\_\_\_ H-W #: \_\_\_\_\_ DATE: \_\_\_\_\_  
 EMAIL: \_\_\_\_\_ FROM (H-W): \_\_\_\_\_  
 FAX NO: \_\_\_\_\_ FILL OUT SURVEY FORM AS COMPLETE AS POSSIBLE.

**DOUBLE OPENING - RIGHT HAND DOOR - CWT. ON LEFT**

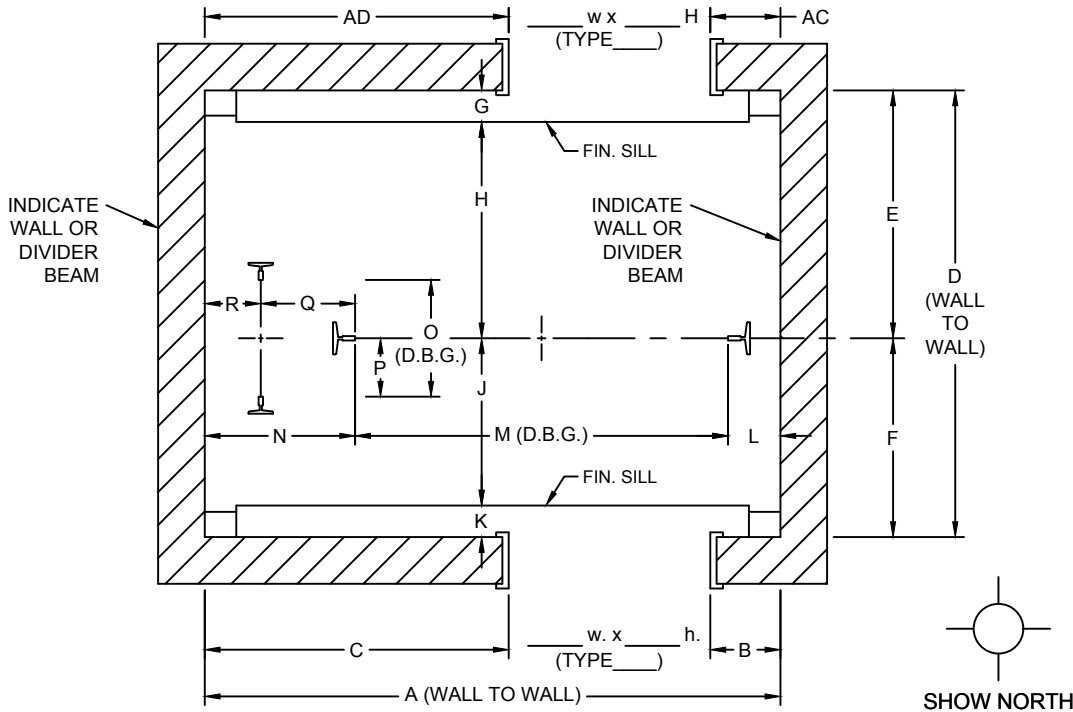

DIMENSIONS AT TIGHTEST POINT	
A	
B	
C	
D	
E	
F	
G	
H	
J	
K	
L	
M	
N	
O	
P	
Q	
R	
S	
T	
U	
V	
W	
X	
Y	
Z	
AA	
AB	
AC	
AD	

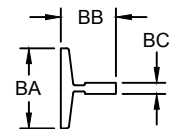
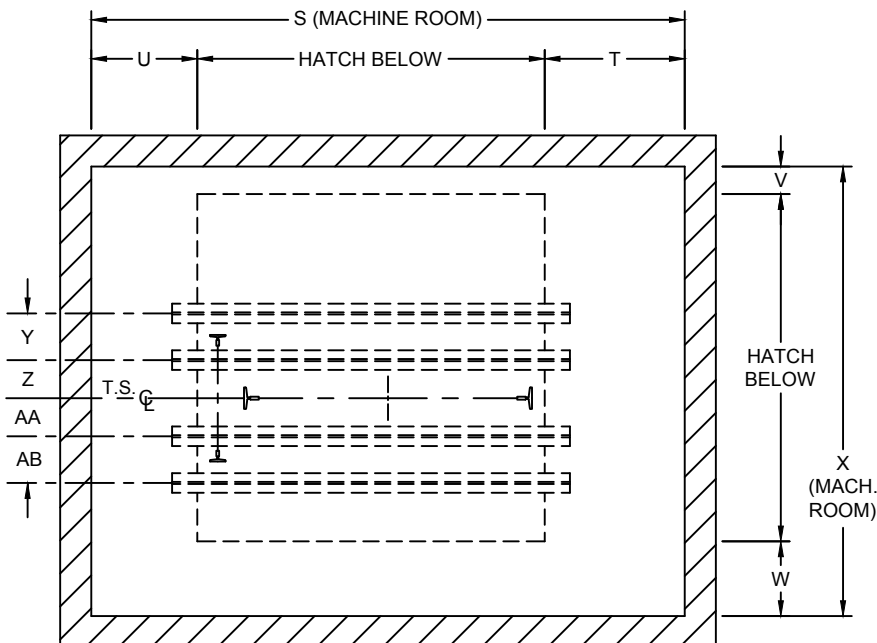

RAIL DIMENSIONS		
	CAR	CWT.
BA		
BB		
BC		
LB./FT.		



#1 Hollister-Whitney Parkway  
 Quincy, IL 62305  
 Phone: 217-222-0466  
 Fax: 217-222-0493

*Hollister-Whitney*  
 ELEVATOR CO. LLC

www.hollisterwhitney.com  
 sales@hwec.com  
 layouts@hwec.com  
 engineering@hwec.com

ENGINEERING CONTACT: \_\_\_\_\_ JOB NAME: \_\_\_\_\_  
 COMPANY: \_\_\_\_\_ ELEV. #: \_\_\_\_\_ H-W #: \_\_\_\_\_ DATE: \_\_\_\_\_  
 EMAIL: \_\_\_\_\_ FROM (H-W): \_\_\_\_\_  
 FAX NO: \_\_\_\_\_ FILL OUT SURVEY FORM AS COMPLETE AS POSSIBLE.

**CORNERPOST - FRONT AND RIGHT SIDE OPENINGS - CWT. ON LEFT**

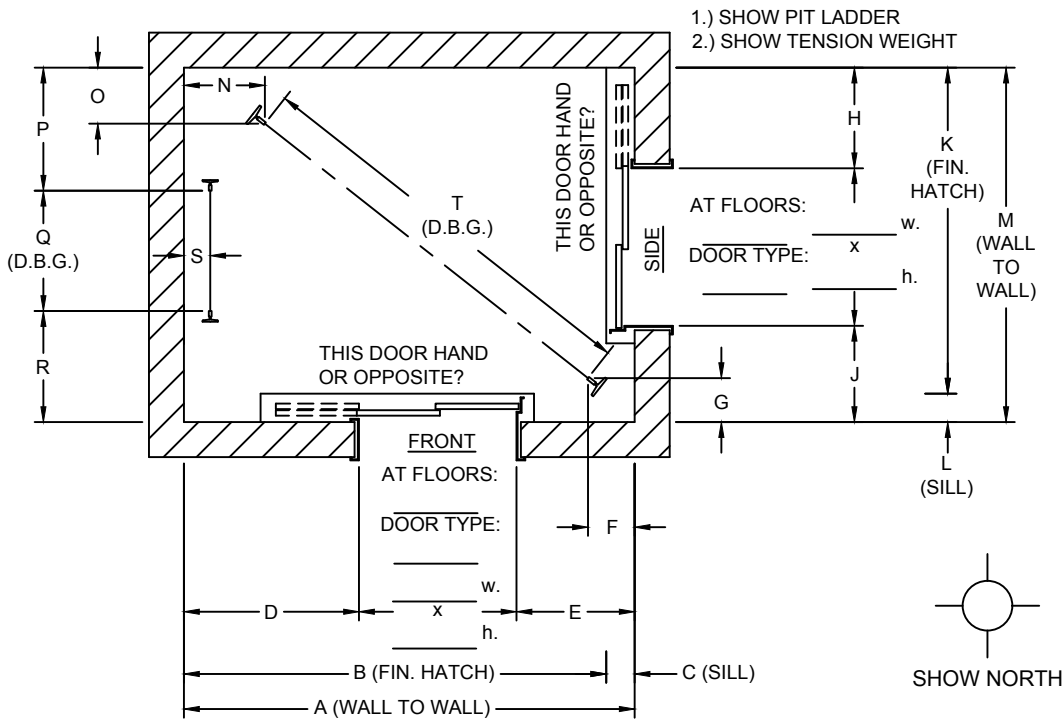

DIMENSIONS AT TIGHTEST POINT	
A	
B	
C	
D	
E	
F	
G	
H	
J	
K	
L	
M	
N	
O	
P	
Q	
R	
S	
T	
U	
V	
W	
X	
Y	
Z	
AA	
AB	
AC	
AD	

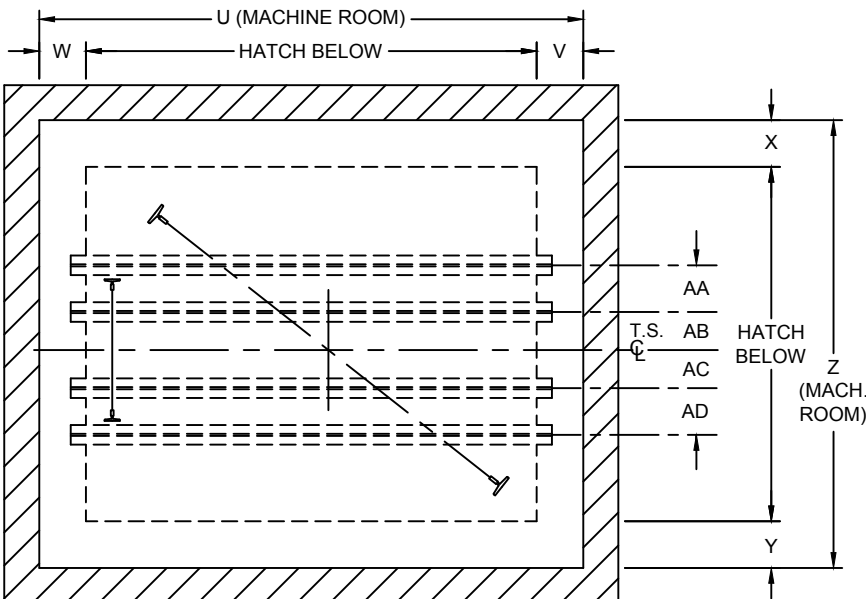

MACHINE BEAM SIZE: \_\_\_\_\_ H. x \_\_\_\_\_ W.  
 INDICATE MACHINE ROOM DOOR LOCATION & HAND

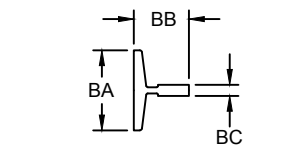

RAIL DIMENSIONS		
	CAR	CWT.
BA		
BB		
BC		
LB./FT.		



#1 Hollister-Whitney Parkway  
 Quincy, IL 62305  
 Phone: 217-222-0466  
 Fax: 217-222-0493

*Hollister-Whitney*  
 ELEVATOR CO. LLC

www.hollisterwhitney.com  
 sales@hwec.com  
 layouts@hwec.com  
 engineering@hwec.com

ENGINEERING CONTACT: \_\_\_\_\_ JOB NAME: \_\_\_\_\_  
 COMPANY: \_\_\_\_\_ ELEV. #: \_\_\_\_\_ H-W #: \_\_\_\_\_ DATE: \_\_\_\_\_  
 EMAIL: \_\_\_\_\_ FROM (H-W): \_\_\_\_\_  
 FAX NO: \_\_\_\_\_ FILL OUT SURVEY FORM AS COMPLETE AS POSSIBLE.

**CORNERPOST - FRONT AND LEFT SIDE OPENINGS - CWT. ON RIGHT**

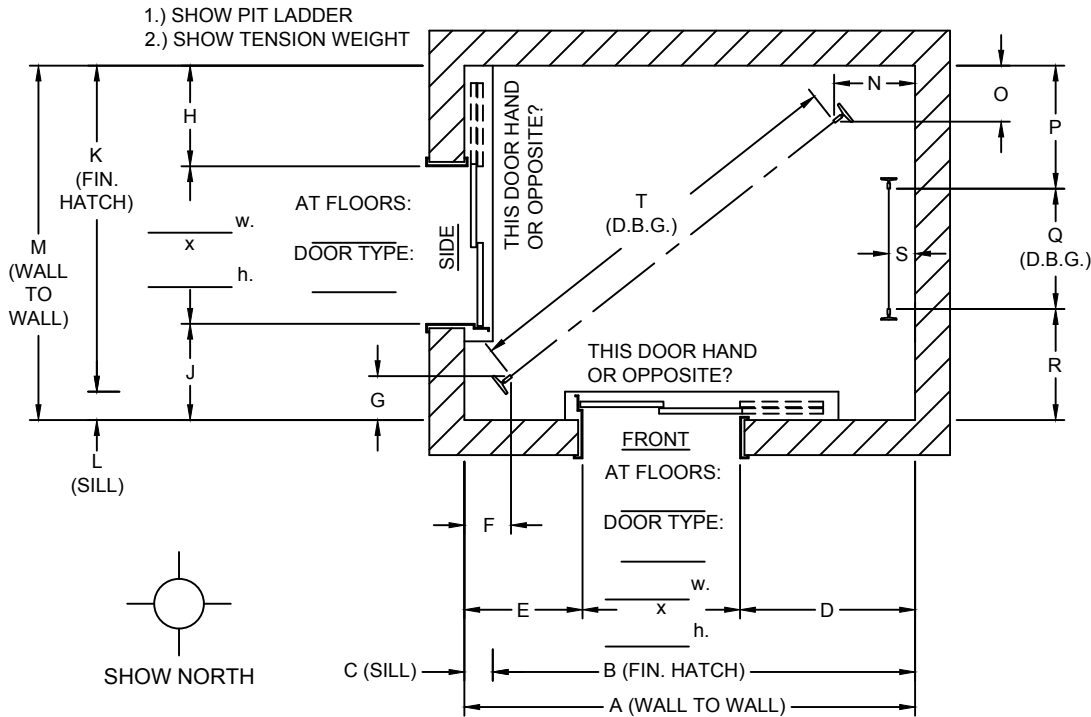

DIMENSIONS AT TIGHTEST POINT	
A	
B	
C	
D	
E	
F	
G	
H	
J	
K	
L	
M	
N	
O	
P	
Q	
R	
S	
T	
U	
V	
W	
X	
Y	
Z	
AA	
AB	
AC	
AD	

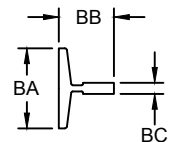
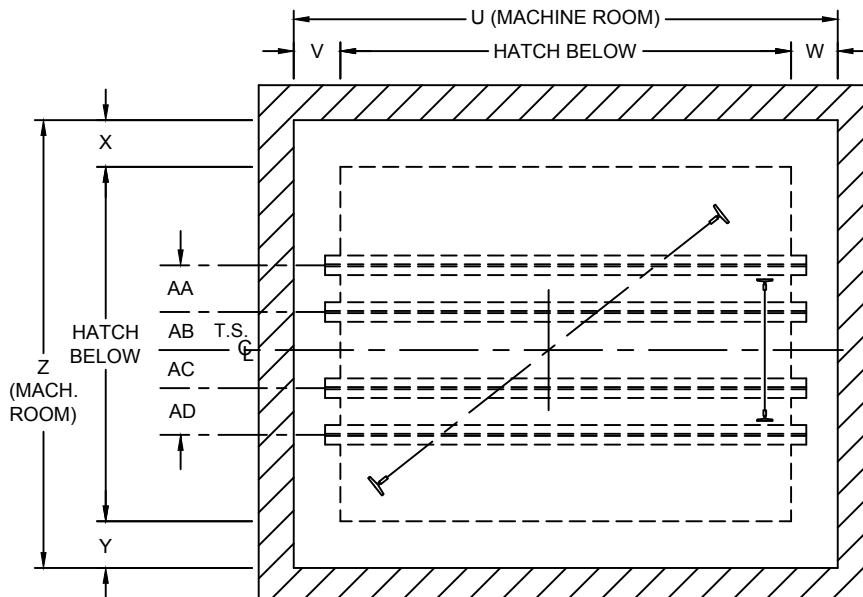

RAIL DIMENSIONS		
	CAR	CWT.
BA		
BB		
BC		
LB./FT.		

MACHINE BEAM SIZE: \_\_\_\_\_ H. x \_\_\_\_\_ W.  
 INDICATE MACHINE ROOM DOOR LOCATION & HAND



#1 Hollister-Whitney Parkway  
 Quincy, IL 62305  
 Phone: 217-222-0466  
 Fax: 217-222-0493

*Hollister-Whitney*  
 ELEVATOR CO. LLC

www.hollisterwhitney.com  
 sales@hwec.com  
 layouts@hwec.com  
 engineering@hwec.com

ENGINEERING CONTACT: \_\_\_\_\_ JOB NAME: \_\_\_\_\_  
 COMPANY: \_\_\_\_\_ ELEV. #: \_\_\_\_\_ H-W #: \_\_\_\_\_ DATE: \_\_\_\_\_  
 EMAIL: \_\_\_\_\_ FROM (H-W): \_\_\_\_\_  
 FAX NO: \_\_\_\_\_ FILL OUT SURVEY FORM AS COMPLETE AS POSSIBLE.

**CORNERPOST - FRONT AND RIGHT SIDE OPENINGS - CWT. AT REAR**

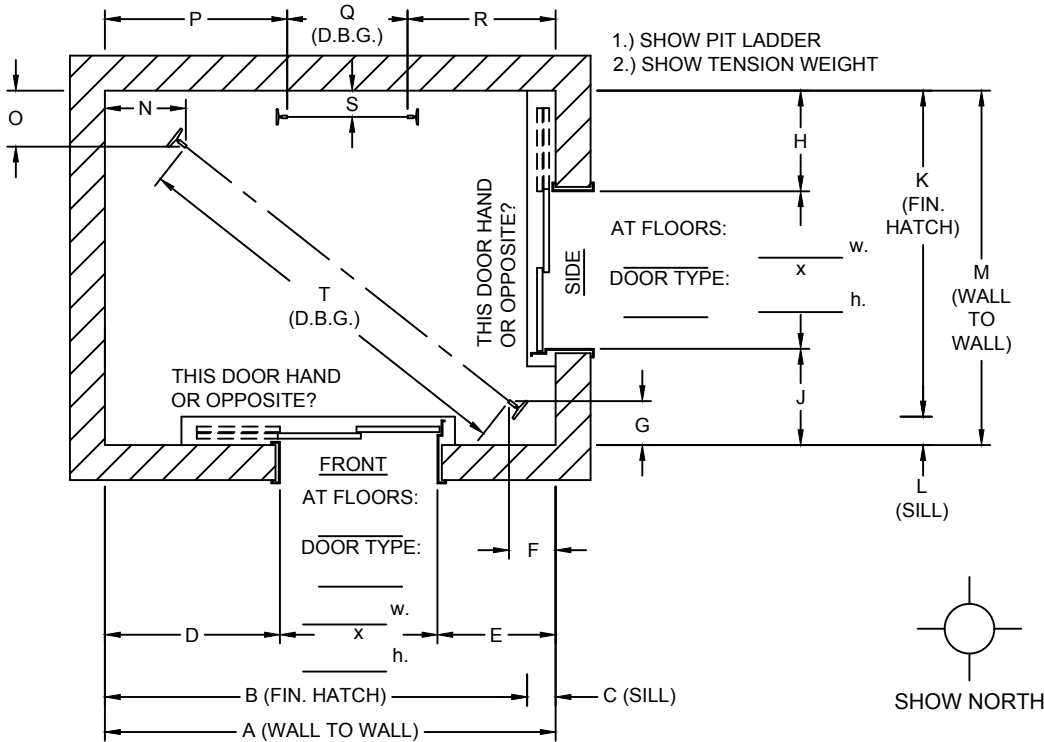

DIMENSIONS AT TIGHTEST POINT	
A	
B	
C	
D	
E	
F	
G	
H	
J	
K	
L	
M	
N	
O	
P	
Q	
R	
S	
T	
U	
V	
W	
X	
Y	
Z	
AA	
AB	
AC	
AD	

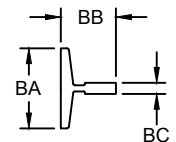
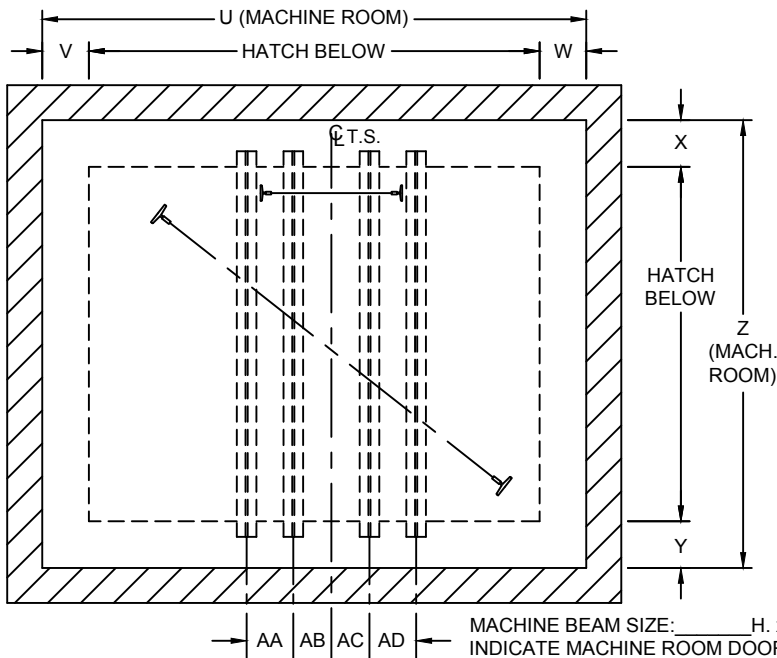

RAIL DIMENSIONS		
	CAR	CWT.
BA		
BB		
BC		
LB./FT.		



#1 Hollister-Whitney Parkway  
 Quincy, IL 62305  
 Phone: 217-222-0466  
 Fax: 217-222-0493

*Hollister-Whitney*  
 ELEVATOR CO. LLC

www.hollisterwhitney.com  
 sales@hwec.com  
 layouts@hwec.com  
 engineering@hwec.com

ENGINEERING CONTACT: \_\_\_\_\_ JOB NAME: \_\_\_\_\_  
 COMPANY: \_\_\_\_\_ ELEV. #: \_\_\_\_\_ H-W #: \_\_\_\_\_ DATE: \_\_\_\_\_  
 EMAIL: \_\_\_\_\_ FROM (H-W): \_\_\_\_\_  
 FAX NO: \_\_\_\_\_ FILL OUT SURVEY FORM AS COMPLETE AS POSSIBLE.

**CORNERPOST - FRONT AND LEFT SIDE OPENINGS - CWT. AT REAR**

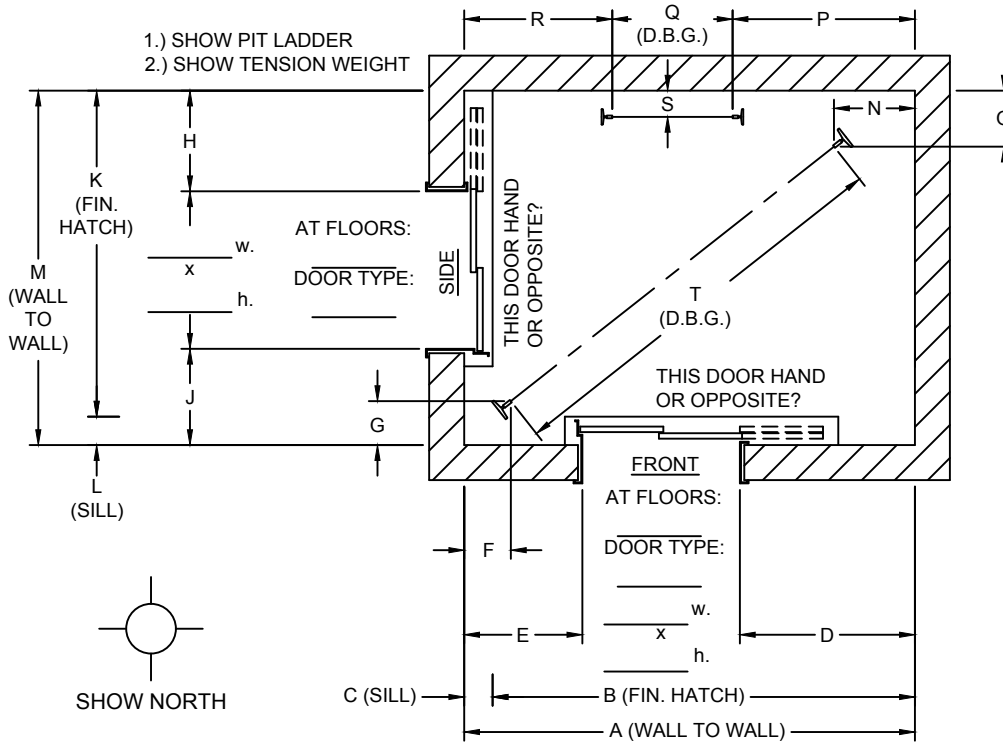

DIMENSIONS AT TIGHTEST POINT	
A	
B	
C	
D	
E	
F	
G	
H	
J	
K	
L	
M	
N	
O	
P	
Q	
R	
S	
T	
U	
V	
W	
X	
Y	
Z	
AA	
AB	
AC	
AD	

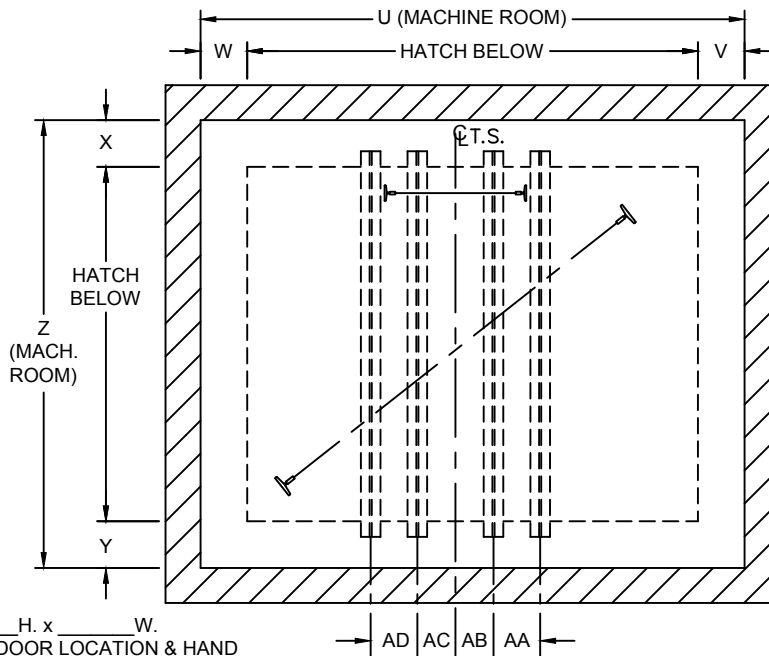

MACHINE BEAM SIZE: \_\_\_\_\_ H. x \_\_\_\_\_ W.  
 INDICATE MACHINE ROOM DOOR LOCATION & HAND

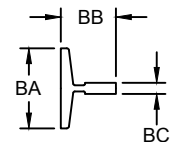

RAIL DIMENSIONS		
	CAR	CWT.
BA		
BB		
BC		
LB./FT.		





#1 Hollister-Whitney Parkway  
 Quincy, IL 62305  
 Phone: 217-222-0466  
 Fax: 217-222-0493

*Hollister-Whitney*  
 ELEVATOR CO. LLC

www.hollisterwhitney.com  
 sales@hwec.com  
 layouts@hwec.com  
 engineering@hwec.com

ENGINEERING CONTACT: \_\_\_\_\_ JOB NAME: \_\_\_\_\_  
 COMPANY: \_\_\_\_\_ ELEV. #: \_\_\_\_\_ H-W #: \_\_\_\_\_ DATE: \_\_\_\_\_  
 EMAIL: \_\_\_\_\_ FROM (H-W): \_\_\_\_\_  
 FAX NO: \_\_\_\_\_ FILL OUT SURVEY FORM AS COMPLETE AS POSSIBLE.

**FREIGHT PLAN VIEW**

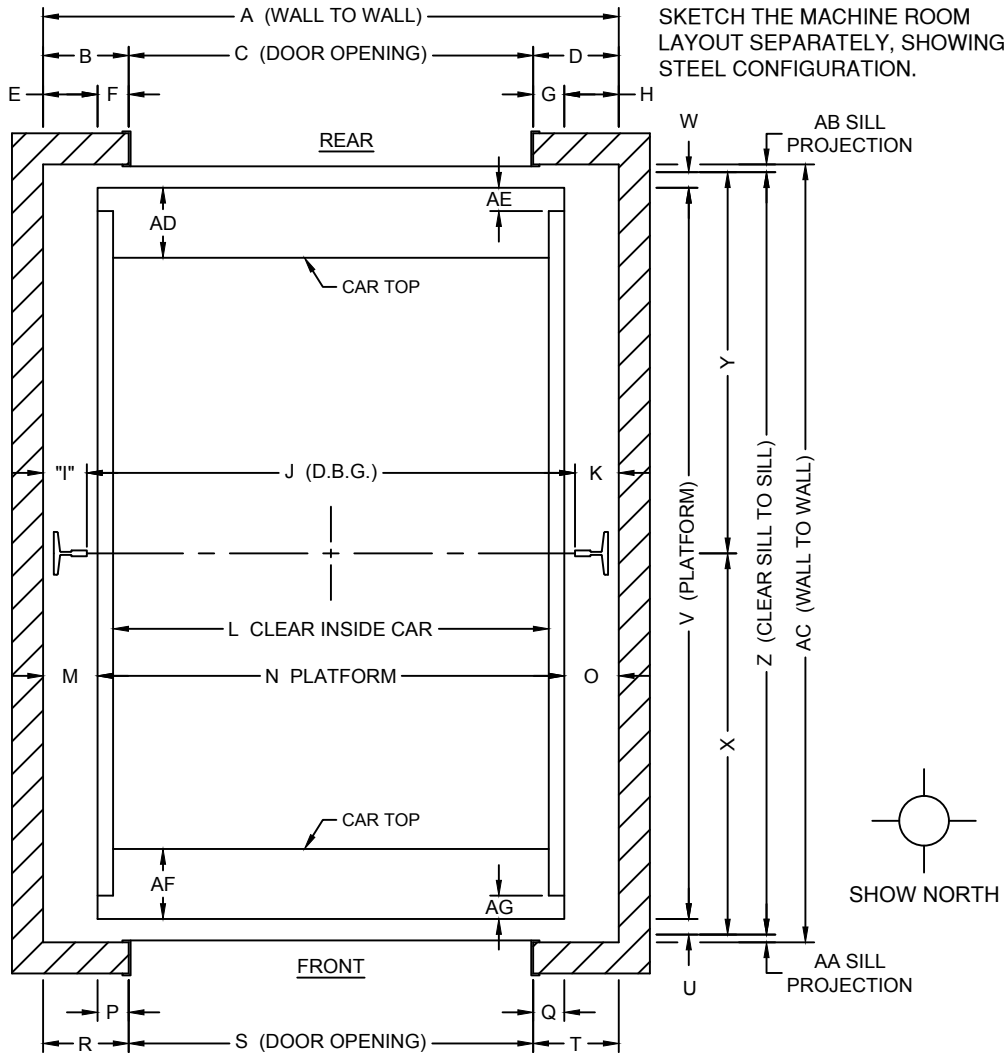

- LOCATE CAMS, INTERLOCKS AND VISION PANEL (FRONT & REAR).
- IF GATE IS TO BE REUSED LOCATE & DIMENSION WEIGHT BOXES.

DIMENSIONS AT TIGHTEST POINT	
A	
B	
C	
D	
E	
F	
G	
H	
I	
J	
K	
L	
M	
N	
O	
P	
Q	
R	
S	
T	
U	
V	
W	
X	
Y	
Z	
AA	
AB	
AC	
AD	
AE	
AF	
AG	

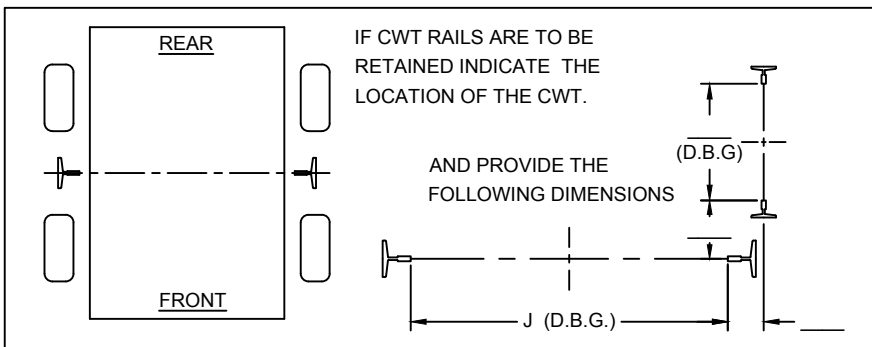

RAIL DIMENSIONS		
	CAR	CWT.
BA		
BB		
BC		
LB./FT.		



#1 Hollister-Whitney Parkway  
 Quincy, IL 62305  
 Phone: 217-222-0466  
 Fax: 217-222-0493

*Hollister-Whitney*  
 ELEVATOR CO. LLC

www.hollisterwhitney.com  
 sales@hwec.com  
 layouts@hwec.com  
 engineering@hwec.com

ENGINEERING CONTACT: \_\_\_\_\_ JOB NAME: \_\_\_\_\_  
 COMPANY: \_\_\_\_\_ ELEV. #: \_\_\_\_\_ H-W #: \_\_\_\_\_ DATE: \_\_\_\_\_  
 EMAIL: \_\_\_\_\_ FROM (H-W): \_\_\_\_\_  
 FAX NO: \_\_\_\_\_ FILL OUT SURVEY FORM AS COMPLETE AS POSSIBLE.

**BASEMENT-SET, MACHINE AT (LEFT) REAR & CWT AT (RIGHT) REAR**

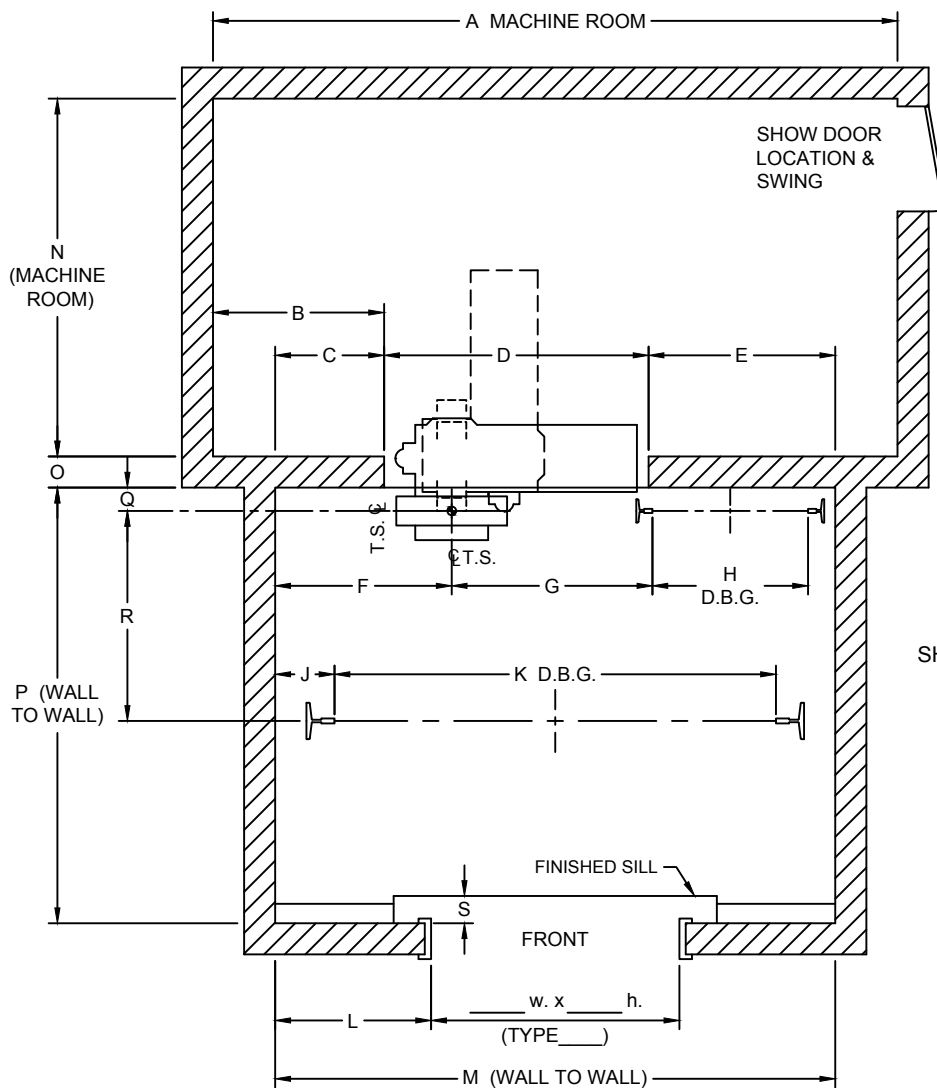

DIMENSIONS AT TIGHTEST POINT	
A	
B	
C	
D	
E	
F	
G	
H	
J	
K	
L	
M	
N	
O	
P	
Q	
R	
S	

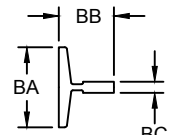

RAIL DIMENSIONS		
	CAR	CWT.
BA		
BB		
BC		
LB./FT.		



#1 Hollister-Whitney Parkway  
 Quincy, IL 62305  
 Phone: 217-222-0466  
 Fax: 217-222-0493

*Hollister-Whitney*  
 ELEVATOR CO. LLC

www.hollisterwhitney.com  
 sales@hwec.com  
 layouts@hwec.com  
 engineering@hwec.com

ENGINEERING CONTACT: \_\_\_\_\_ JOB NAME: \_\_\_\_\_  
 COMPANY: \_\_\_\_\_ ELEV. #: \_\_\_\_\_ H-W #: \_\_\_\_\_ DATE: \_\_\_\_\_  
 EMAIL: \_\_\_\_\_ FROM (H-W): \_\_\_\_\_  
 FAX NO: \_\_\_\_\_ FILL OUT SURVEY FORM AS COMPLETE AS POSSIBLE.

**BASEMENT-SET, MACHINE AT (RIGHT) REAR & CWT AT (LEFT) REAR**

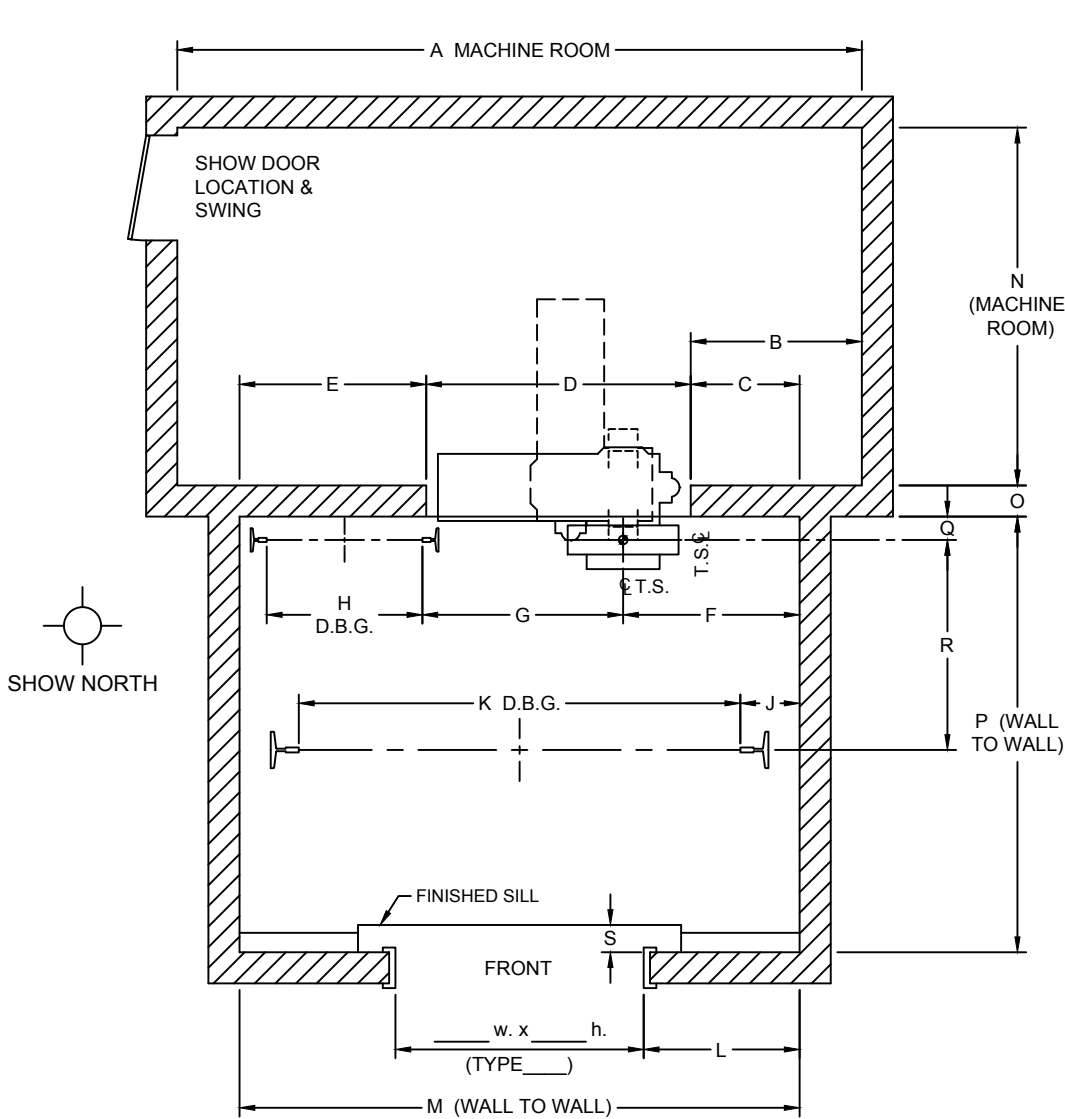

DIMENSIONS AT TIGHTEST POINT	
A	
B	
C	
D	
E	
F	
G	
H	
J	
K	
L	
M	
N	
O	
P	
Q	
R	
S	

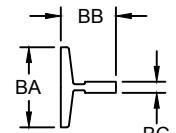

RAIL DIMENSIONS		
	CAR	CWT.
BA		
BB		
BC		
LB./FT.		



#1 Hollister-Whitney Parkway  
 Quincy, IL 62305  
 Phone: 217-222-0466  
 Fax: 217-222-0493

*Hollister-Whitney*  
 ELEVATOR CO. LLC

www.hollisterwhitney.com  
 sales@hwec.com  
 layouts@hwec.com  
 engineering@hwec.com

ENGINEERING CONTACT: \_\_\_\_\_ JOB NAME: \_\_\_\_\_  
 COMPANY: \_\_\_\_\_ ELEV. #: \_\_\_\_\_ H-W #: \_\_\_\_\_ DATE: \_\_\_\_\_  
 EMAIL: \_\_\_\_\_ FROM (H-W): \_\_\_\_\_  
 FAX NO: \_\_\_\_\_ FILL OUT SURVEY FORM AS COMPLETE AS POSSIBLE.

**BASEMENT-SET, MACHINE AT SIDE & CWT AT REAR**

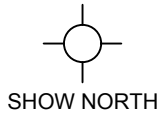
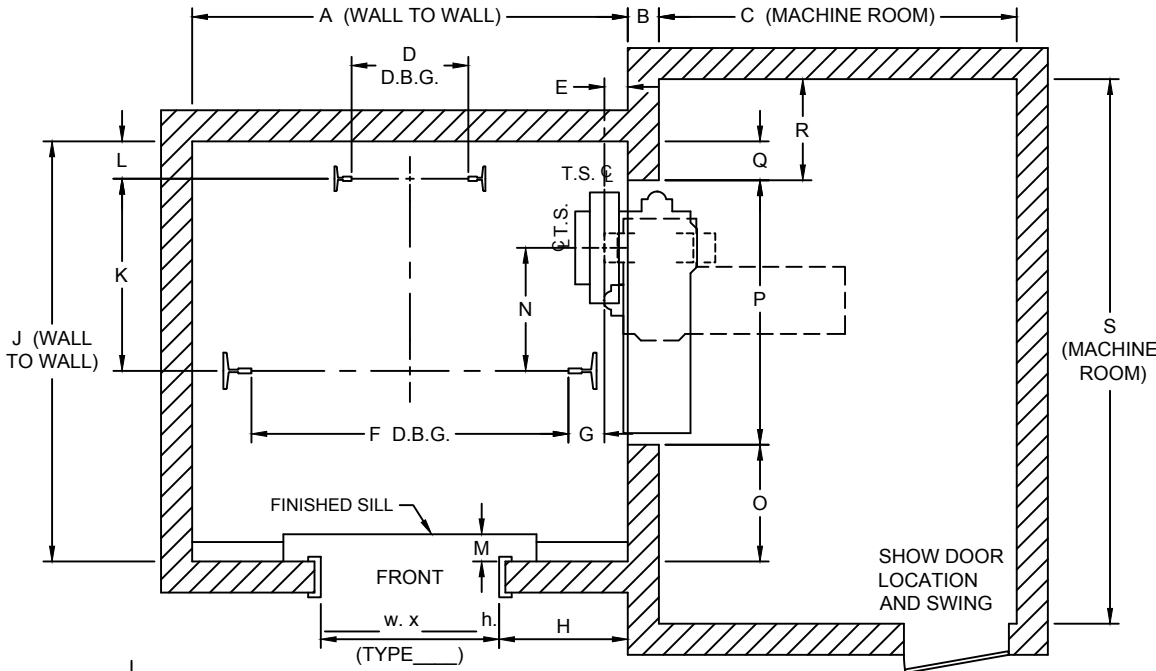

OR  
 'X' OUT THE PLAN VIEW THAT DOES NOT APPLY

DIMENSIONS AT TIGHTEST POINT	
A	
B	
C	
D	
E	
F	
G	
H	
J	
K	
L	
M	
N	
O	
P	
Q	
R	
S	

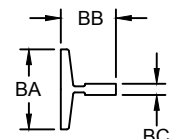
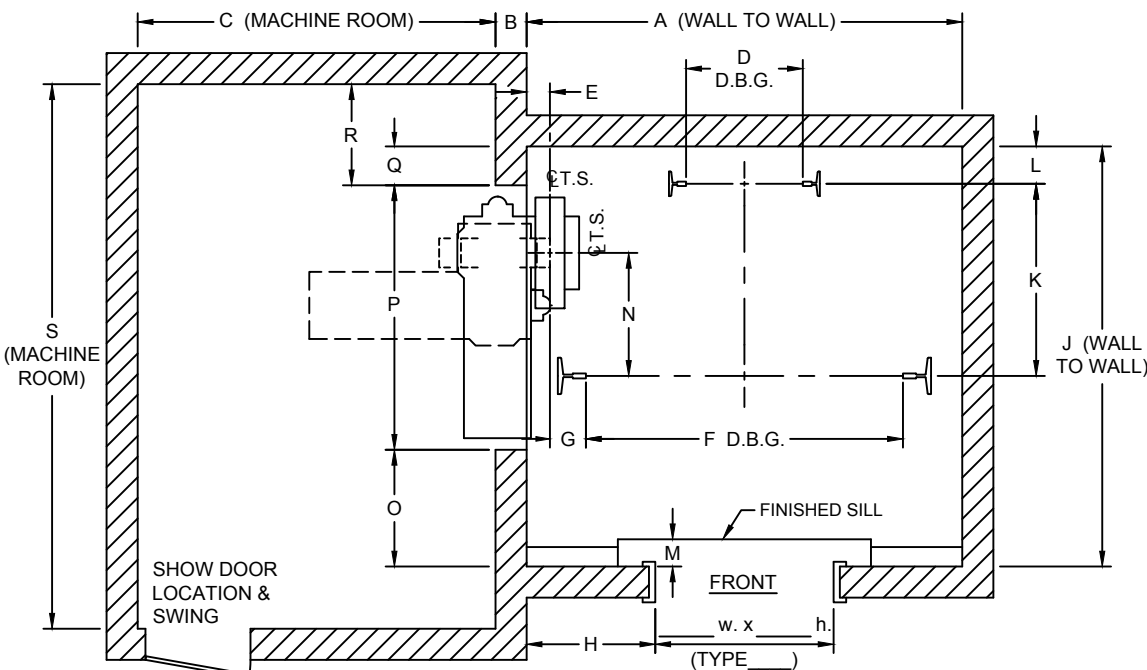

RAIL DIMENSIONS		
	CAR	CWT.
BA		
BB		
BC		
LB./FT.		



#1 Hollister-Whitney Parkway  
 Quincy, IL 62305  
 Phone: 217-222-0466  
 Fax: 217-222-0493

*Hollister-Whitney*  
 ELEVATOR CO. LLC

www.hollisterwhitney.com  
 sales@hwec.com  
 layouts@hwec.com  
 engineering@hwec.com

ENGINEERING CONTACT: \_\_\_\_\_ JOB NAME: \_\_\_\_\_  
 COMPANY: \_\_\_\_\_ ELEV. #: \_\_\_\_\_ H-W #: \_\_\_\_\_ DATE: \_\_\_\_\_  
 EMAIL: \_\_\_\_\_ FROM (H-W): \_\_\_\_\_  
 FAX NO: \_\_\_\_\_ FILL OUT SURVEY FORM AS COMPLETE AS POSSIBLE.

**BASEMENT-SET, MACHINE AT SIDE & CWT ON OPPOSITE SIDE**

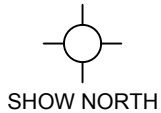
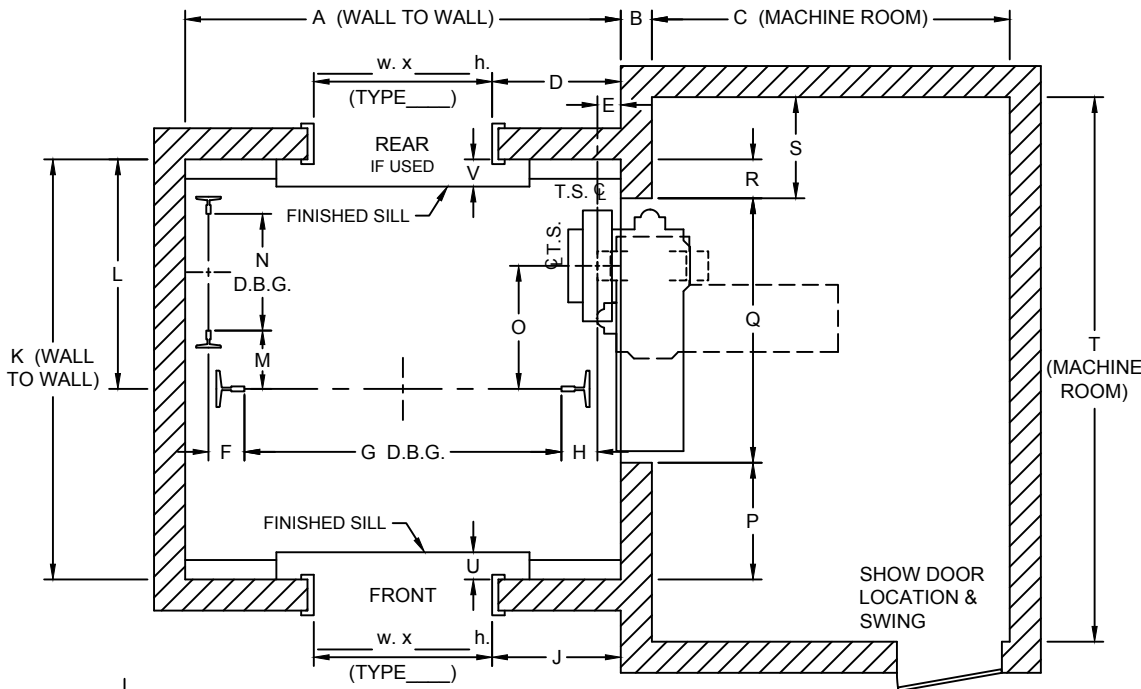

OR  
 'X' OUT THE PLAN VIEW THAT DOES NOT APPLY

DIMENSIONS AT TIGHTEST POINT	
A	
B	
C	
D	
E	
F	
G	
H	
J	
K	
L	
M	
N	
O	
P	
Q	
R	
S	
T	
U	
V	

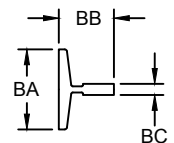
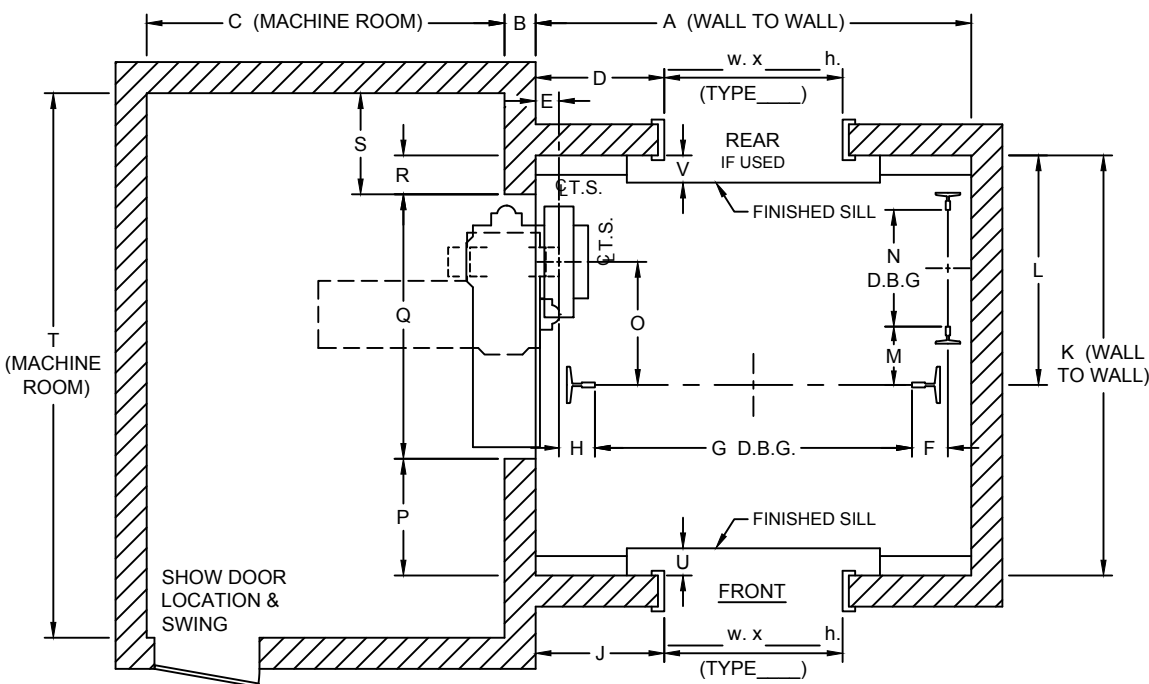

RAIL DIMENSIONS		
	CAR	CWT.
BA		
BB		
BC		
LB./FT.		



#1 Hollister-Whitney Parkway  
 Quincy, IL 62305  
 Phone: 217-222-0466  
 Fax: 217-222-0493

*Hollister-Whitney*  
 ELEVATOR CO. LLC

www.hollisterwhitney.com  
 sales@hwec.com  
 layouts@hwec.com  
 engineering@hwec.com

ENGINEERING CONTACT: \_\_\_\_\_ JOB NAME: \_\_\_\_\_  
 COMPANY: \_\_\_\_\_ ELEV. #: \_\_\_\_\_ H-W #: \_\_\_\_\_ DATE: \_\_\_\_\_  
 EMAIL: \_\_\_\_\_ FROM (H-W): \_\_\_\_\_  
 FAX NO: \_\_\_\_\_ FILL OUT SURVEY FORM AS COMPLETE AS POSSIBLE.

**BASEMENT-SET, MACHINE AT SIDE & CWT ON SAME SIDE**

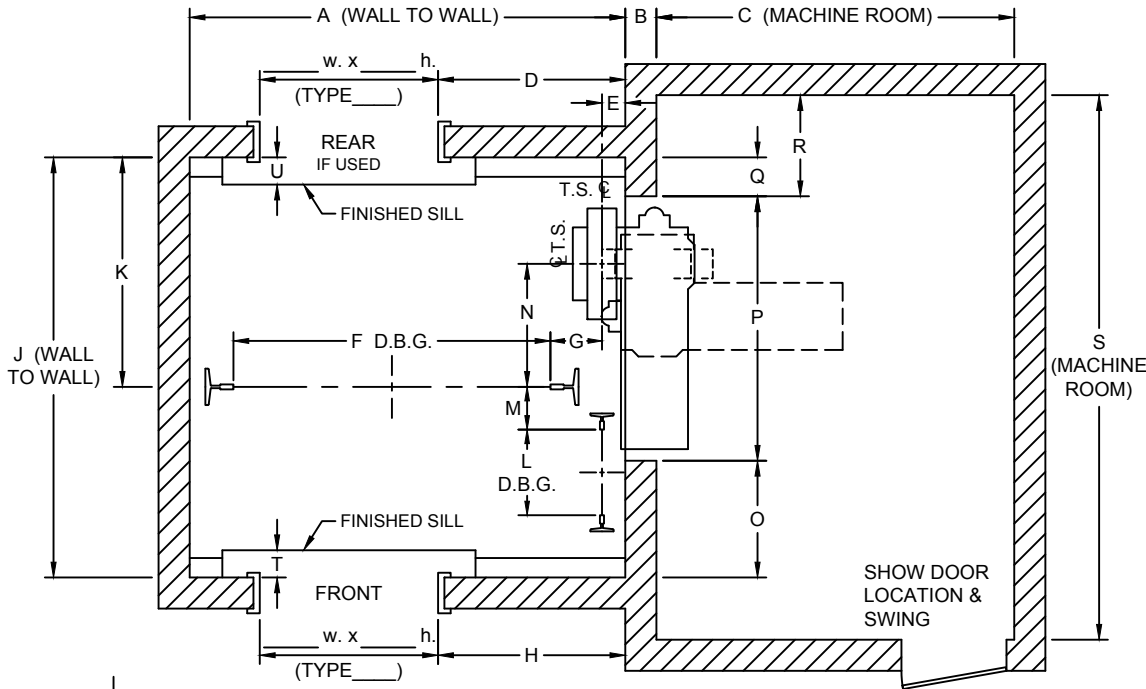

DIMENSIONS AT TIGHTEST POINT	
A	
B	
C	
D	
E	
F	
G	
H	
J	
K	
L	
M	
N	
O	
P	
Q	
R	
S	
T	
U	



OR  
 'X' OUT THE PLAN VIEW THAT DOES NOT APPLY

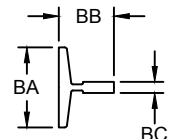
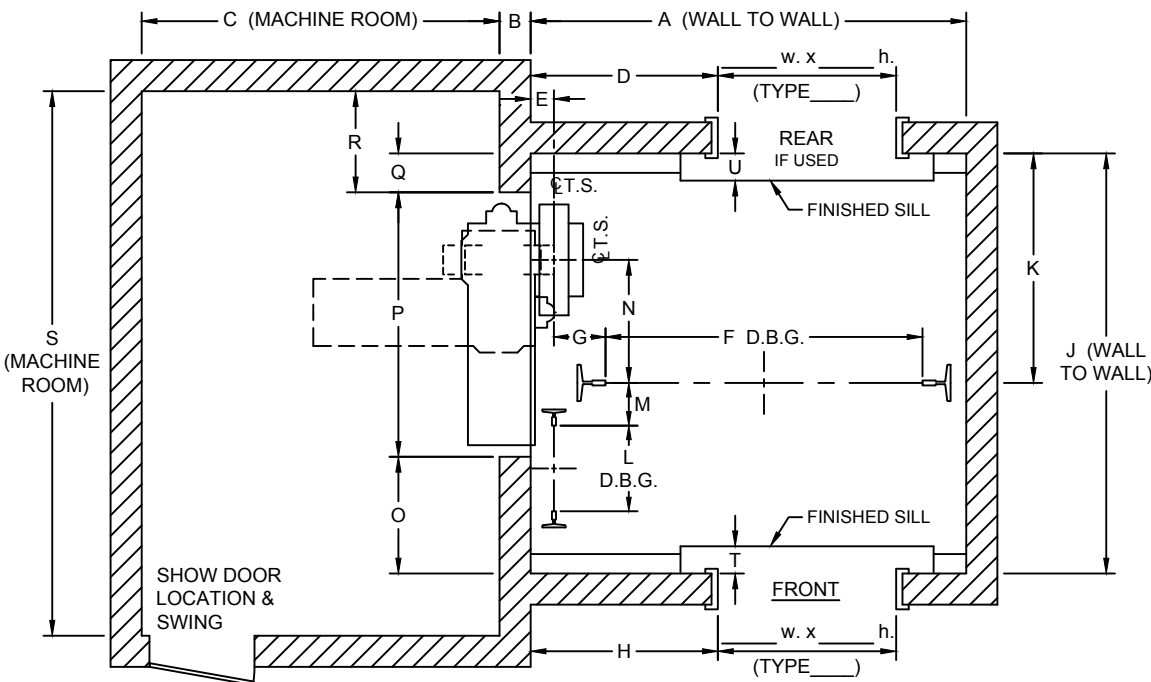

RAIL DIMENSIONS		
	CAR	CWT.
BA		
BB		
BC		
LB./FT.		



#1 Hollister-Whitney Parkway  
 Quincy, IL 62305  
 Phone: 217-222-0466  
 Fax: 217-222-0493

*Hollister-Whitney*  
 ELEVATOR CO. LLC

www.hollisterwhitney.com  
 sales@hwec.com  
 layouts@hwec.com  
 engineering@hwec.com

ENGINEERING CONTACT: \_\_\_\_\_  
 COMPANY: \_\_\_\_\_  
 EMAIL: \_\_\_\_\_  
 FAX NO: \_\_\_\_\_

JOB NAME: \_\_\_\_\_  
 ELEV. #: \_\_\_\_\_ H-W #: \_\_\_\_\_ DATE: \_\_\_\_\_  
 FROM (H-W): \_\_\_\_\_  
 FILL OUT SURVEY FORM AS COMPLETE AS POSSIBLE.

**OVERHEAD STEEL BASEMENT-SET, MACHINE & CWT AT REAR**

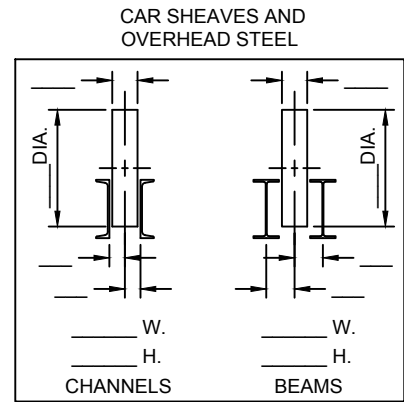
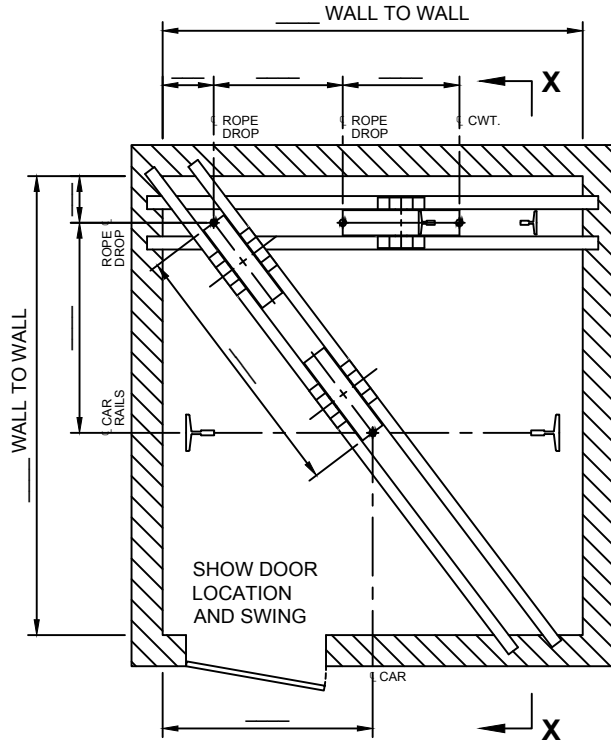

'X' OUT OVERHEAD STEEL THAT DOES NOT APPLY

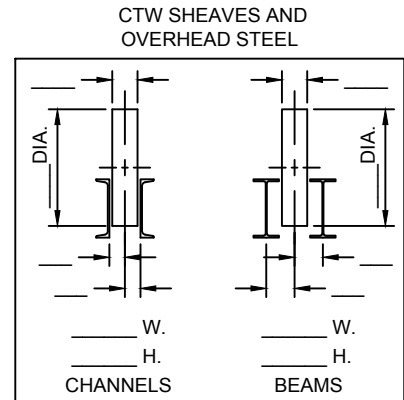

'X' OUT OVERHEAD STEEL THAT DOES NOT APPLY

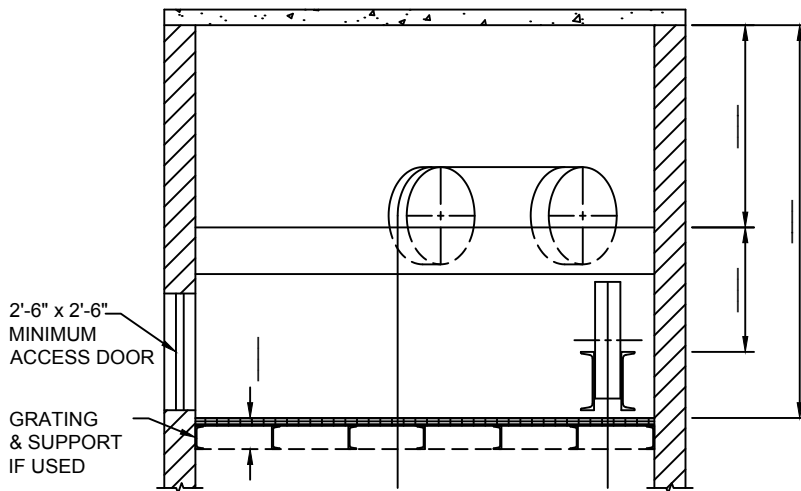

**SECTION "X-X"**



#1 Hollister-Whitney Parkway  
 Quincy, IL 62305  
 Phone: 217-222-0466  
 Fax: 217-222-0493

*Hollister-Whitney*  
 ELEVATOR CO. LLC

www.hollisterwhitney.com  
 sales@hwec.com  
 layouts@hwec.com  
 engineering@hwec.com

ENGINEERING CONTACT: \_\_\_\_\_ JOB NAME: \_\_\_\_\_  
 COMPANY: \_\_\_\_\_ ELEV. #: \_\_\_\_\_ H-W #: \_\_\_\_\_ DATE: \_\_\_\_\_  
 EMAIL: \_\_\_\_\_ FROM (H-W): \_\_\_\_\_  
 FAX NO: \_\_\_\_\_ FILL OUT SURVEY FORM AS COMPLETE AS POSSIBLE.

**OVERHEAD STEEL BASEMENT-SET, MACHINE AT SIDE & CWT AT REAR**

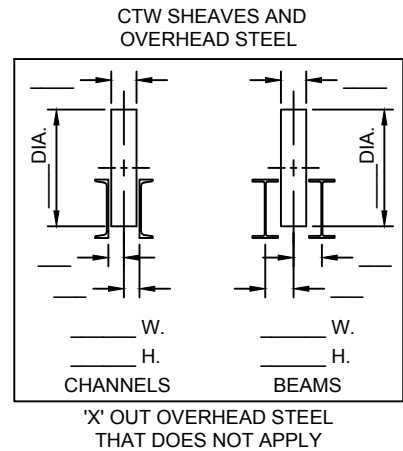
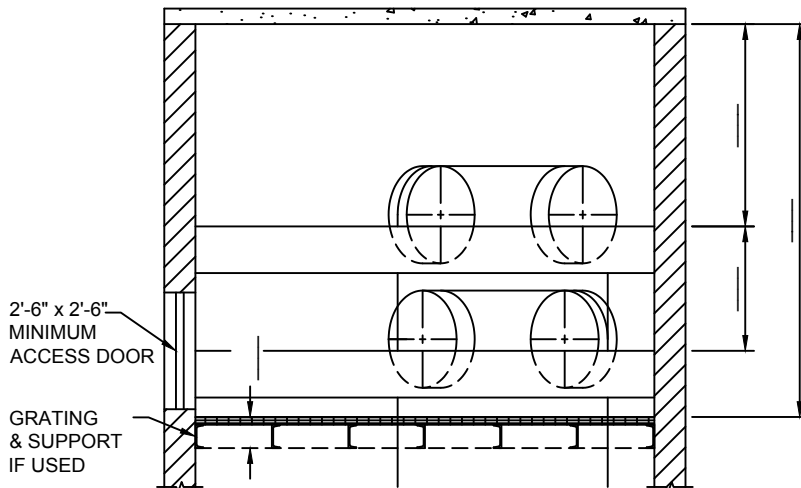
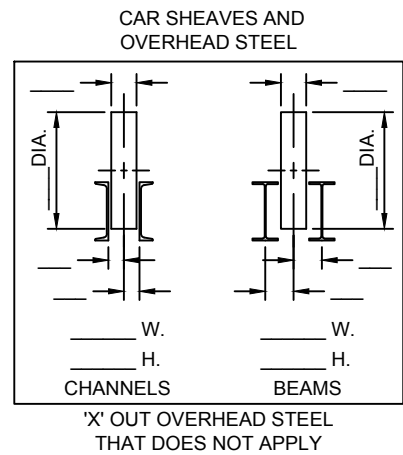
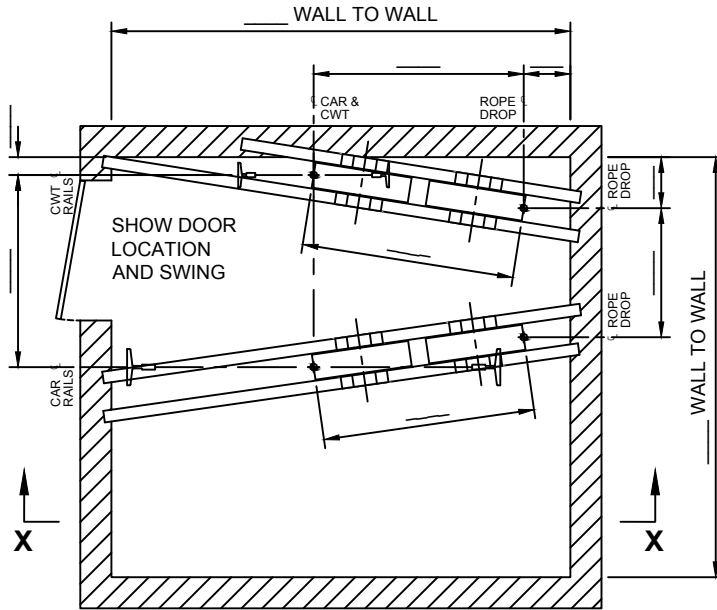

**SECTION "X-X"**





#1 Hollister-Whitney Parkway  
 Quincy, IL 62305  
 Phone: 217-222-0466  
 Fax: 217-222-0493

*Hollister-Whitney*  
 ELEVATOR CO. LLC

www.hollisterwhitney.com  
 sales@hwec.com  
 layouts@hwec.com  
 engineering@hwec.com

ENGINEERING CONTACT: \_\_\_\_\_ JOB NAME: \_\_\_\_\_  
 COMPANY: \_\_\_\_\_ ELEV. #: \_\_\_\_\_ H-W #: \_\_\_\_\_ DATE: \_\_\_\_\_  
 EMAIL: \_\_\_\_\_ FROM (H-W): \_\_\_\_\_  
 FAX NO: \_\_\_\_\_ FILL OUT SURVEY FORM AS COMPLETE AS POSSIBLE.

**EXISTING BASEMENT MACHINE SURVEY (FOR LAYOUTS)**

INSTRUCTIONS:

1. SELECT "HAND" OF MACHINE.
2. SELECT "TYPE" OF MACHINE ARRANGEMENT

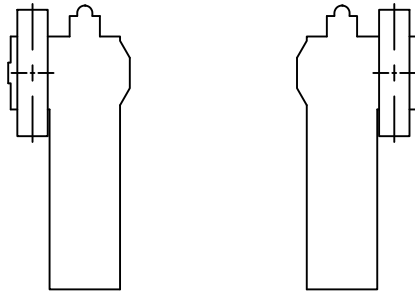

LEFT HAND       RIGHT HAND

"HAND" OF BASEMENT SET MACHINES

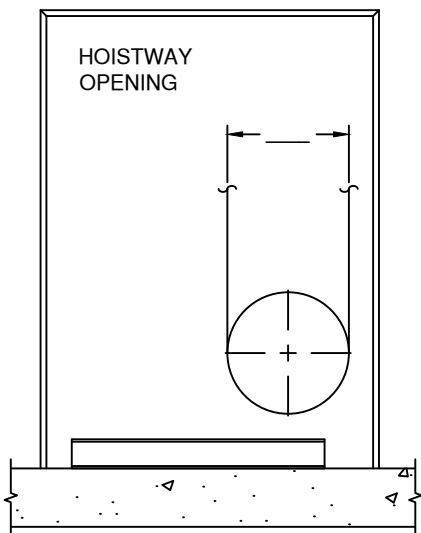

"B.S." BASEMENT SET MACHINES

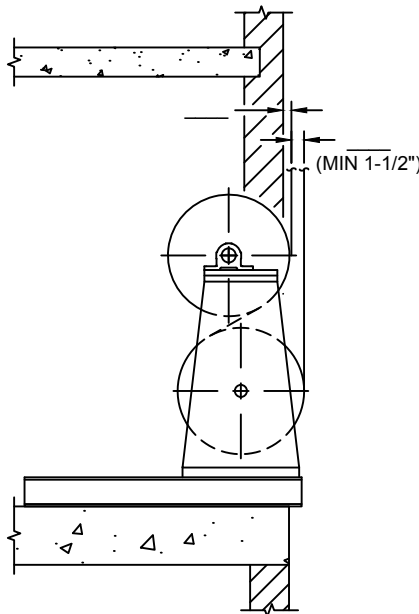

"O.D." OVERHEAD DEFLECTOR  
 BASEMENT SET MACHINES  
 (WITH INTEGRATED  
 DEFLECTOR SHEAVE)

"TYPE" OF BASEMENT SET MACHINES

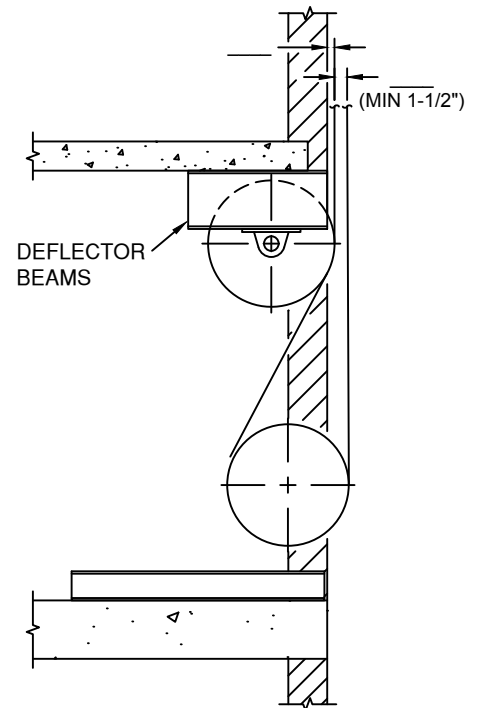

"B.S." BASEMENT SET MACHINES  
 (WITH SEPARATE  
 DEFLECTOR SHEAVE)



#1 Hollister-Whitney Parkway  
 Quincy, IL 62305  
 Phone: 217-222-0466  
 Fax: 217-222-0493

*Hollister-Whitney*  
 ELEVATOR CO. LLC

www.hollisterwhitney.com  
 sales@hwec.com  
 layouts@hwec.com  
 engineering@hwec.com

ENGINEERING CONTACT: \_\_\_\_\_ JOB NAME: \_\_\_\_\_  
 COMPANY: \_\_\_\_\_ ELEV. #: \_\_\_\_\_ H-W #: \_\_\_\_\_ DATE: \_\_\_\_\_  
 EMAIL: \_\_\_\_\_ FROM (H-W): \_\_\_\_\_  
 FAX NO: \_\_\_\_\_ FILL OUT SURVEY FORM AS COMPLETE AS POSSIBLE.

**EXISTING BUFFERS, PIT CHANNELS, SAFETIES,  
 GOVERNORS, TENSION WEIGHTS, MACHINE/SHEAVES**

**EXISTING BUFFERS**

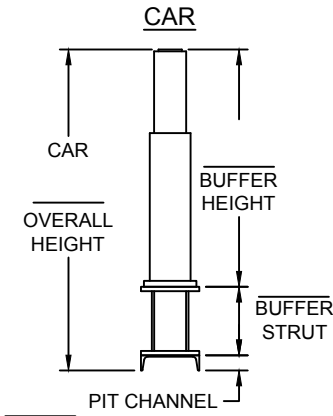

**EXISTING OIL BUFFERS**

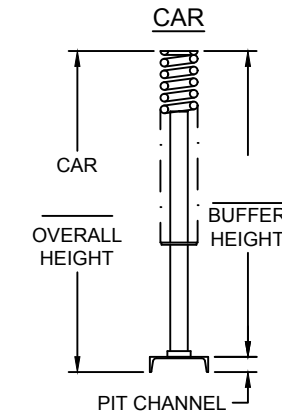
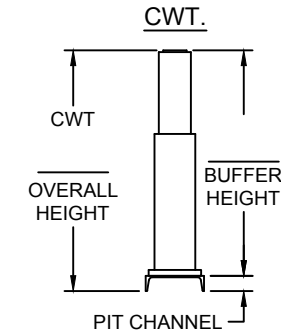

**EXISTING SPRING BUFFERS**

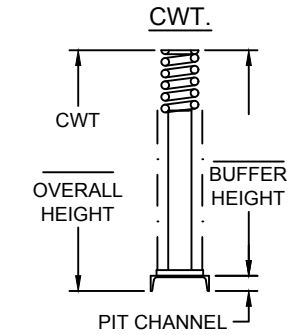

**EXISTING SAFETY / GOVERNOR / TENSION WGT.**

- SAFETY PULL-THRU IN POUNDS? \_\_\_\_\_
- INDICATE QUADRANT FOR GOVERNOR / TENSION WEIGHT
- INDICATE IF GOVERNOR FACES OUTWARD
- LOCATION OF SAFETY PICK-UP ARM? X=\_\_\_\_\_ Y=\_\_\_\_\_
- ROPE DIAMETER? \_\_\_\_\_
- RAIL SIZE? \_\_\_\_\_
- STILE CHANNEL SIZE? \_\_\_\_\_

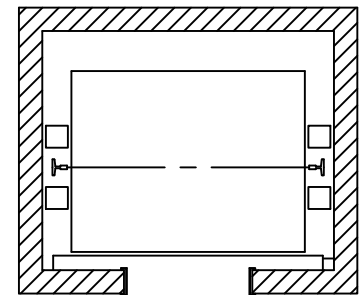
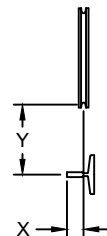

**EXISTING MACHINE / SHEAVES**

- HOIST ROPES: QUANTITY \_\_\_\_\_ DIAMETER \_\_\_\_\_
- PITCH OF HOIST ROPES? (€ TO € OF GROOVES ON FACE OF TRACTION SHEAVE): \_\_\_\_\_
- HAND OF MACHINE? (STANDING AT MOTOR END, WHICH SIDE IS T.S. LOCATED ON?) \_\_\_\_\_
- ROPING - 1:1 OR 2:1? \_\_\_\_\_
- DIAMETER OF EXISTING DEFLECTOR SHEAVE? \_\_\_\_\_
- DIAMETER OF EXISTING OVERHEAD SHEAVES? \_\_\_\_\_
- DIAMETER OF EXISTING CAR SHEAVE(S) \_\_\_\_\_
- DIAMETER OF EXISTING CWT. SHEAVE? \_\_\_\_\_



#1 Hollister-Whitney Parkway  
 Quincy, IL 62305  
 Phone: 217-222-0466  
 Fax: 217-222-0493

*Hollister-Whitney*  
 ELEVATOR CO. LLC

www.hollisterwhitney.com  
 sales@hwec.com  
 layouts@hwec.com  
 engineering@hwec.com

ENGINEERING CONTACT: \_\_\_\_\_ JOB NAME: \_\_\_\_\_  
 COMPANY: \_\_\_\_\_ ELEV. #: \_\_\_\_\_ H-W #: \_\_\_\_\_ DATE: \_\_\_\_\_  
 EMAIL: \_\_\_\_\_ FROM (H-W): \_\_\_\_\_  
 FAX NO: \_\_\_\_\_ FILL OUT SURVEY FORM AS COMPLETE AS POSSIBLE.

**EXISTING CAR SLING AND PLATFORM**

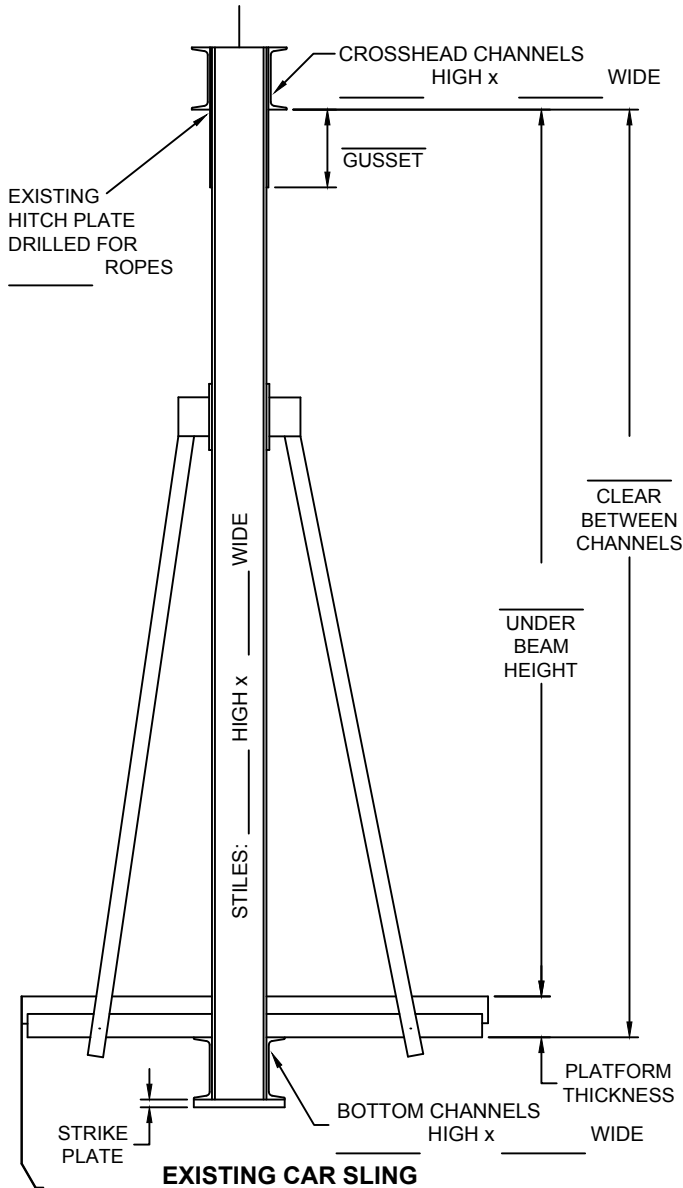

**EXISTING CAR SLING**

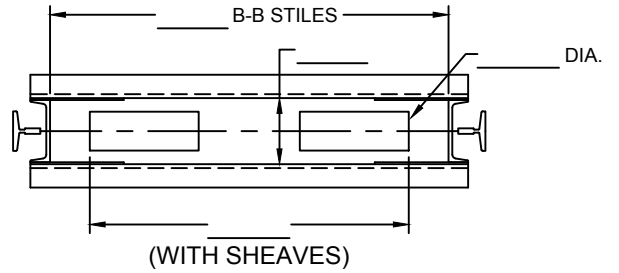

**EXISTING PLATFORM**

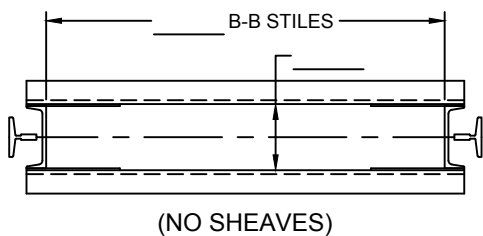
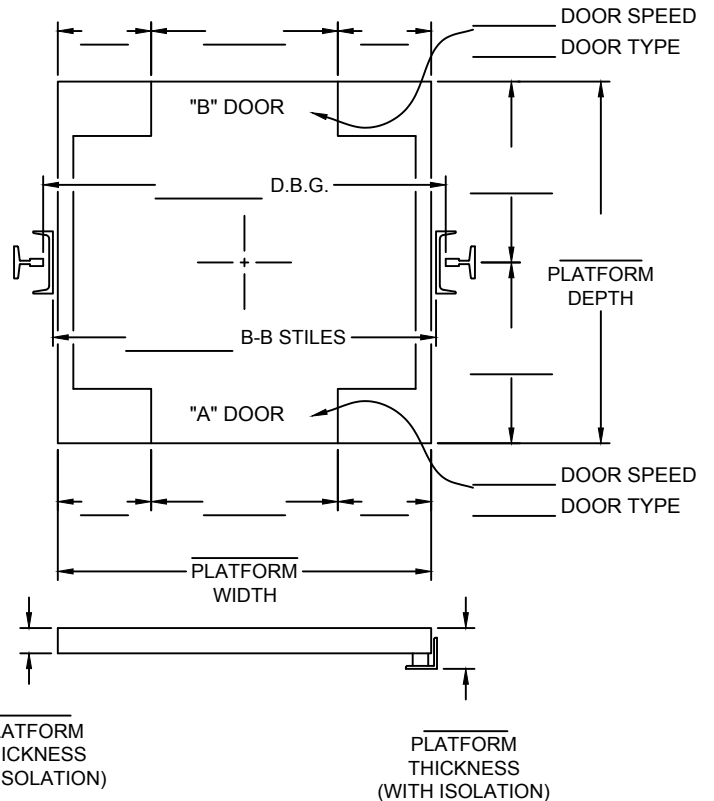

**EXISTING WEIGHTS / DUTY**

EXISTING TOTAL EMPTY CAR WEIGHT: \_\_\_\_\_  
 EXISTING CAPACITY RATING: \_\_\_\_\_  
 EXISTING CAR SPEED: \_\_\_\_\_  
 EXISTING LOAD CLASSIFICATION: \_\_\_\_\_  
 (PASSENGER OR CLASS A, B, C1, C2, C3)



#1 Hollister-Whitney Parkway  
 Quincy, IL 62305  
 Phone: 217-222-0466  
 Fax: 217-222-0493

*Hollister-Whitney*  
 ELEVATOR CO. LLC

www.hollisterwhitney.com  
 sales@hwec.com  
 layouts@hwec.com  
 engineering@hwec.com

ENGINEERING CONTACT: \_\_\_\_\_  
 COMPANY: \_\_\_\_\_  
 EMAIL: \_\_\_\_\_  
 FAX NO: \_\_\_\_\_

JOB NAME: \_\_\_\_\_  
 ELEV. #: \_\_\_\_\_ H-W #: \_\_\_\_\_ DATE: \_\_\_\_\_  
 FROM (H-W): \_\_\_\_\_  
 FILL OUT SURVEY FORM AS COMPLETE AS POSSIBLE.

**EXISTING COUNTERWEIGHT FRAME (WITH AND WITHOUT SHEAVE)**

**EXISTING COUNTERWEIGHT WITH SHEAVE**

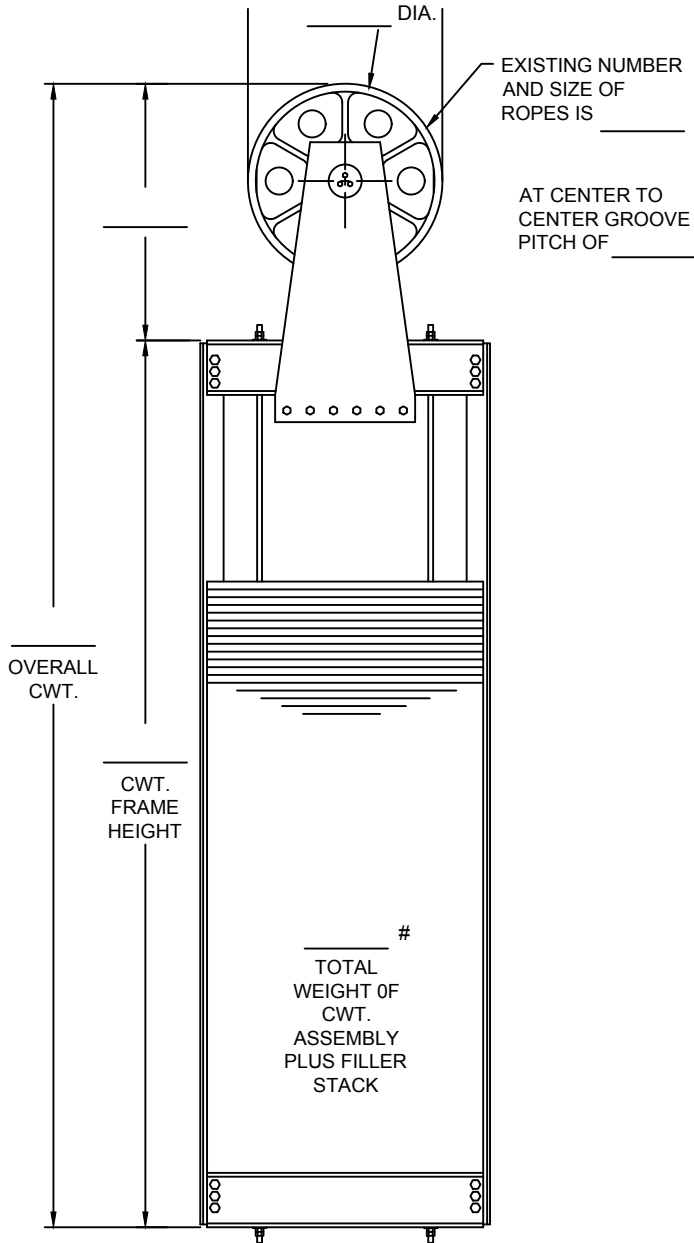

**EXISTING COUNTERWEIGHT WITHOUT SHEAVE**

